

Center Windshield Pattern

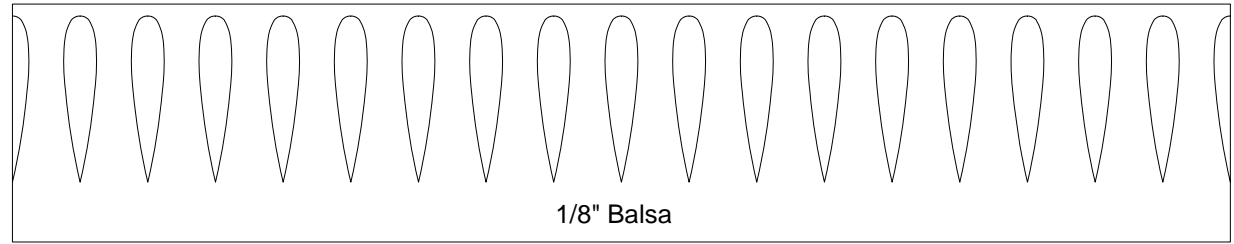

1/8" Balsa

Cowl pattern

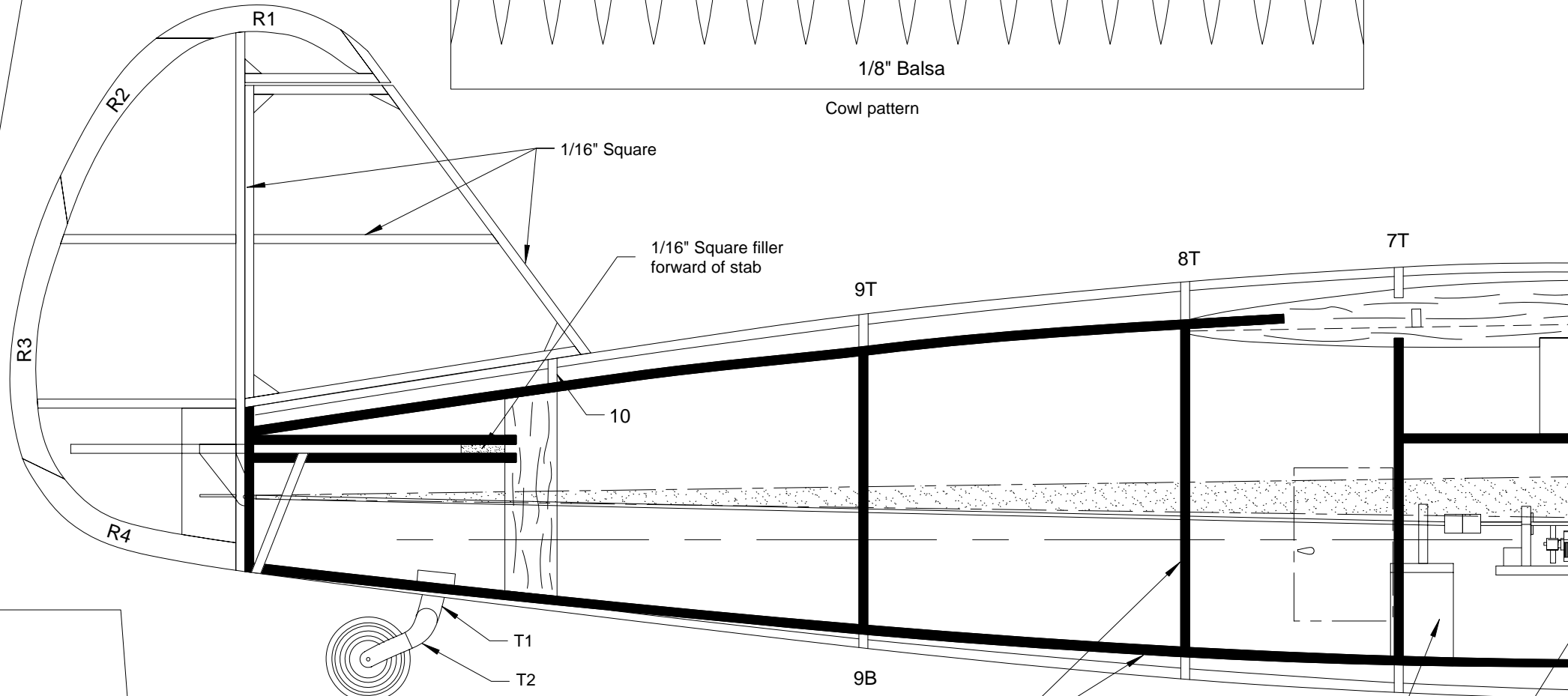

Side Windows Pattern

# Comet Stinson Reliant

For Radio Control

Wingspan - 25"

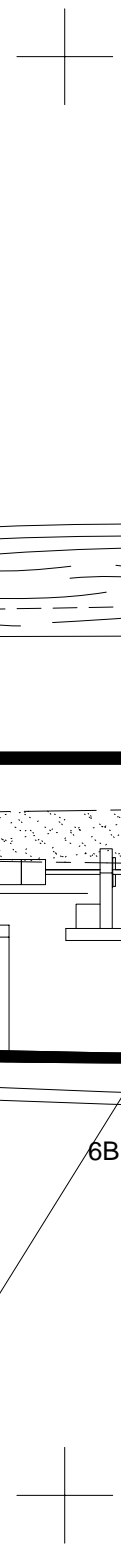
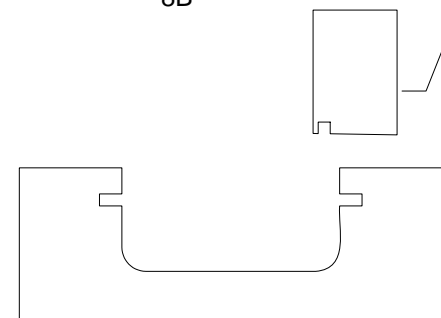
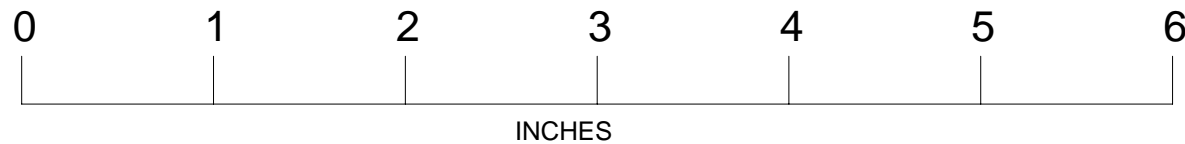

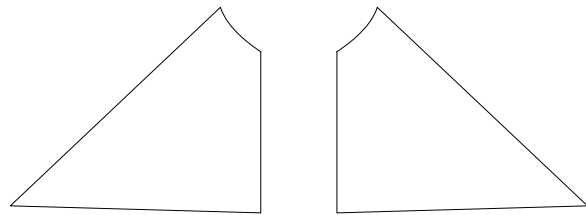

Side Windshield Pattern

Wing struts are 1/16" x 1/8" strip stock sanded to a streamline cross section

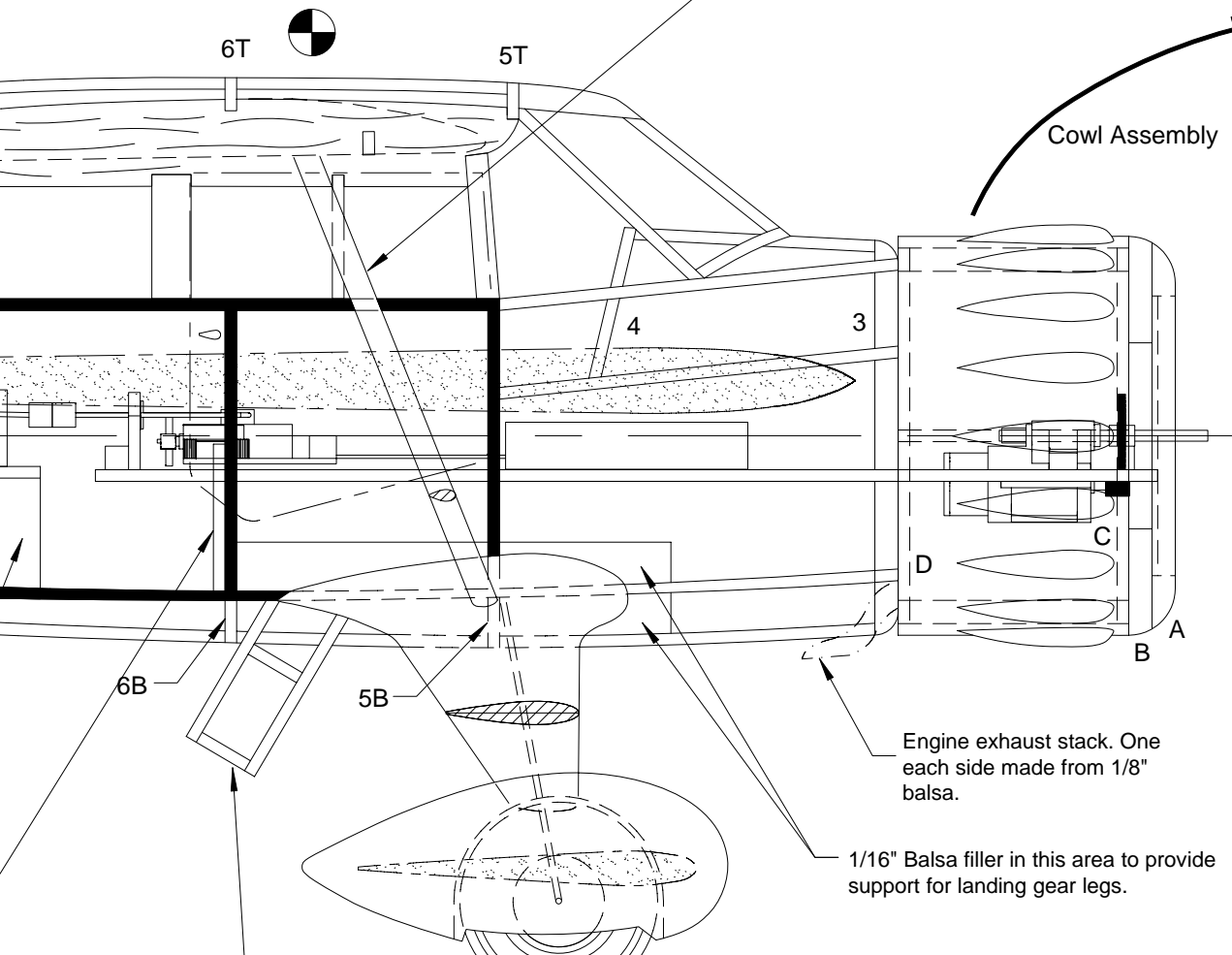

Entry step is made from rounded 1/16" square stock build over the plan. One goes on each side

1/16"X1/8" Balsa strip stock

Cowl Assembly

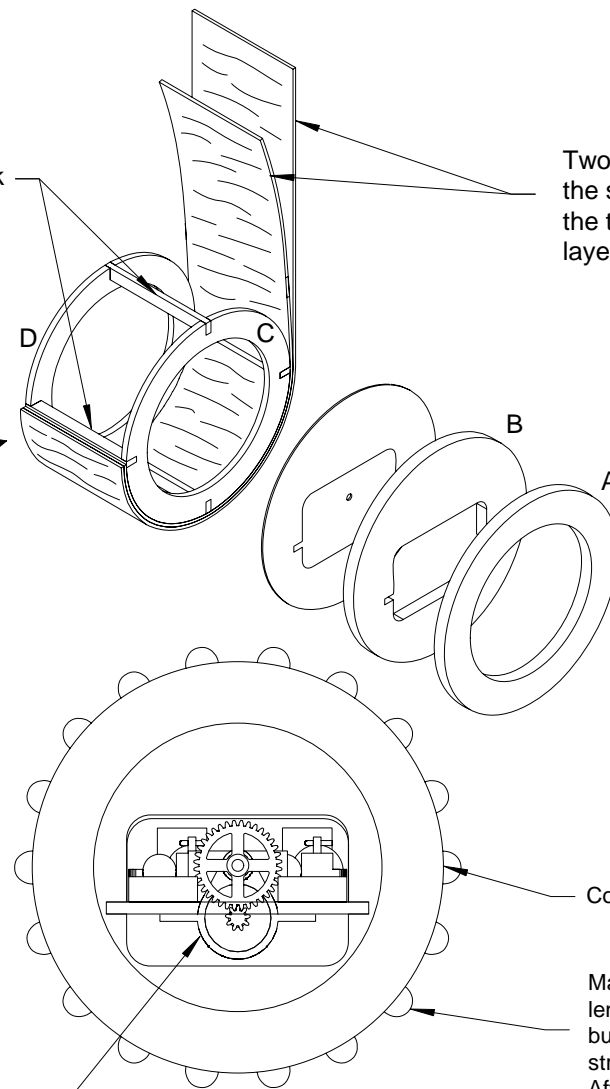

Two laminations of 1/32" balsa. Use the supplied template when cutting the two laminations. Apply a thin layer of glue between laminations.

The cowl nose ring is made from two layers of 1/8" balsa and one layer of 1/64" plywood in the arrangement shown. Do not remove the center plug from the plywood piece until after shaping. Use the center hole in the plywood piece to secure the assembly in a Dremel tool or electric drill. Turn the assembly and shape the radius. After shaping the plywood center plug can be removed.

Cowl bump template seam goes here.

Make cowl bumps by cutting a piece of 3/16" balsa 5" long by the length of the cowl bump wide. Sand this strip to shape of the cowl bump as viewed from the top. Sand one end of the now streamlined strip of balsa to the shape of the cowl bump as viewed from the side. After sanding, cut off the sanded end at the depth of the cowl bump. Repeat this process until you have 18 cowl bumps fabricated. The template provided on the plan can be used to locate each cowl bump. Place the template so the seam is at the quarter point on the side of the cowl.

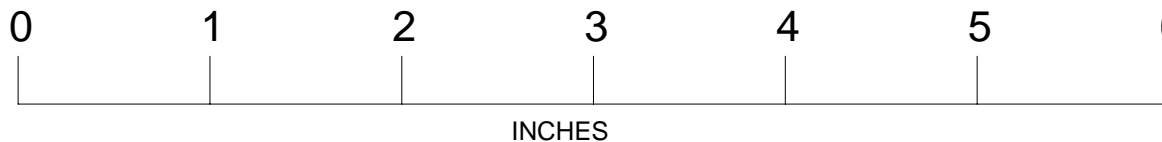

# Comet Stinson Reliant

For Radio Control

Wingspan - 25"

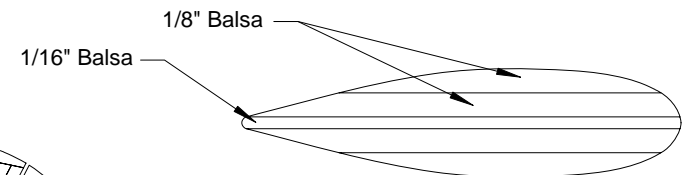
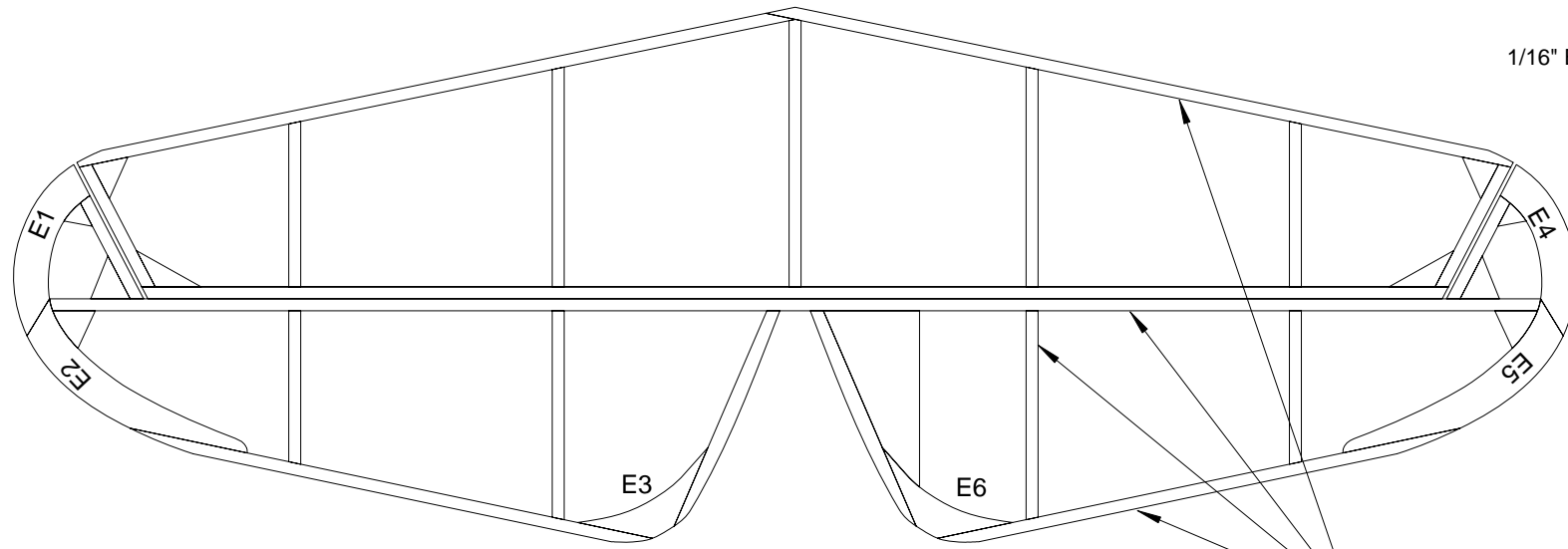

Wheel pant top view

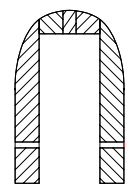

Wheel pant cross section

1/16" Square

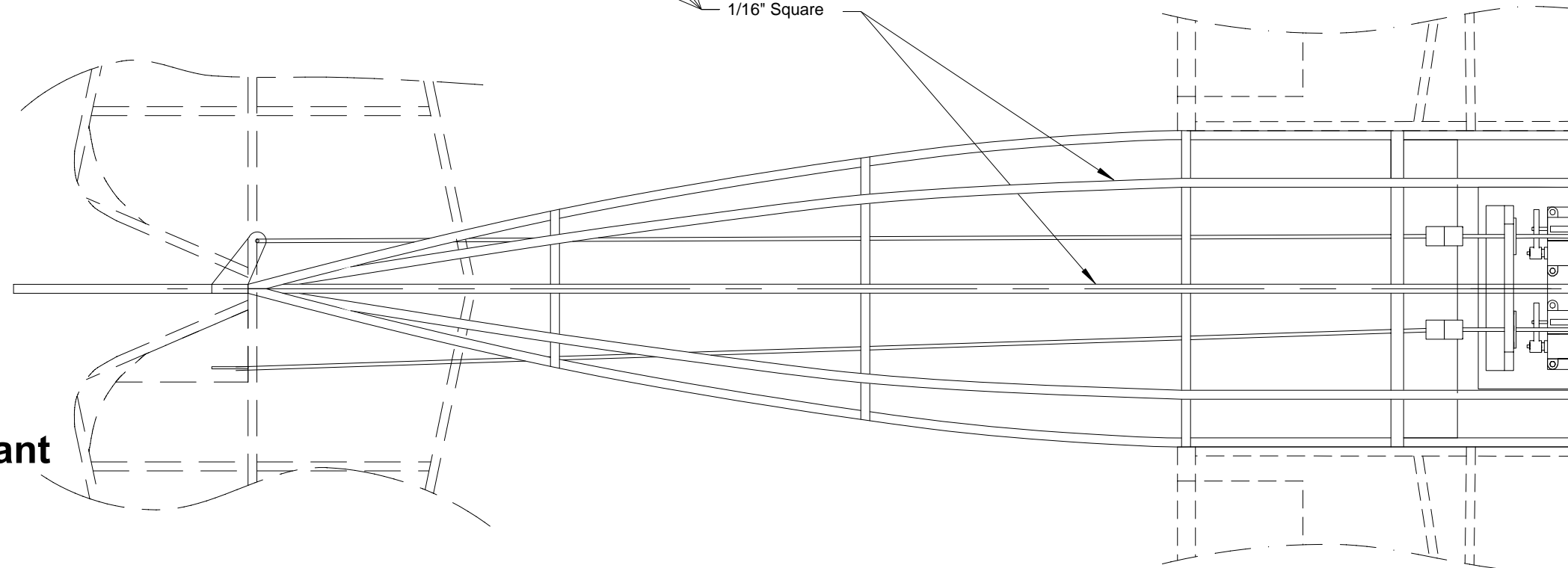

# Comet Stinson Reliant

For Radio Control

Wingspan - 25"



INCHES

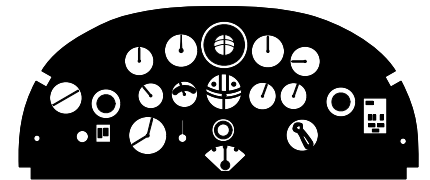
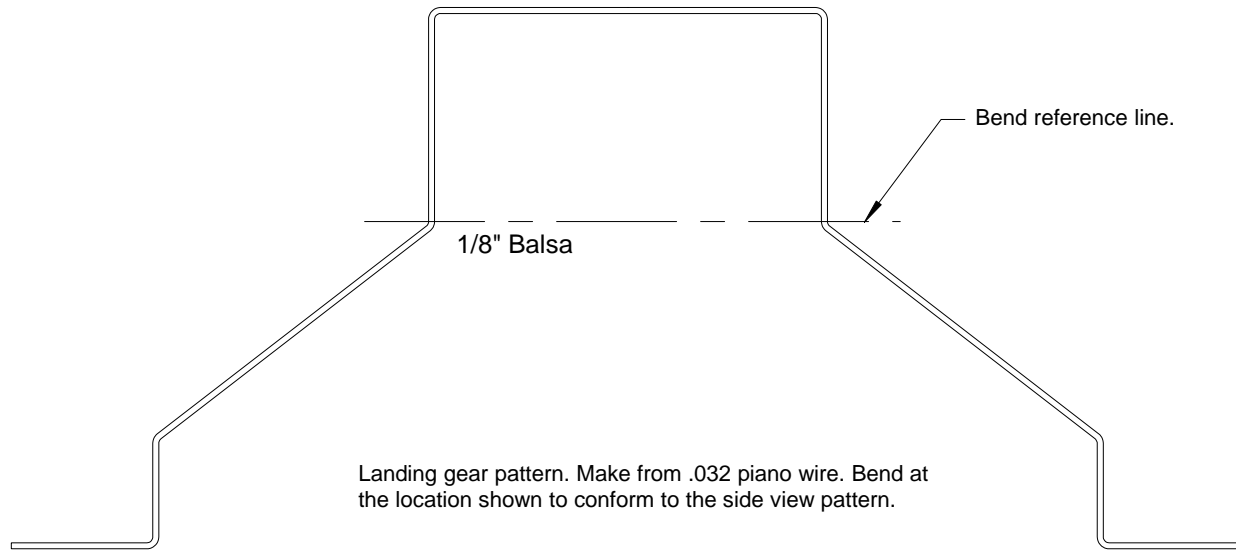
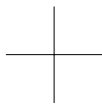

Glue to former 4

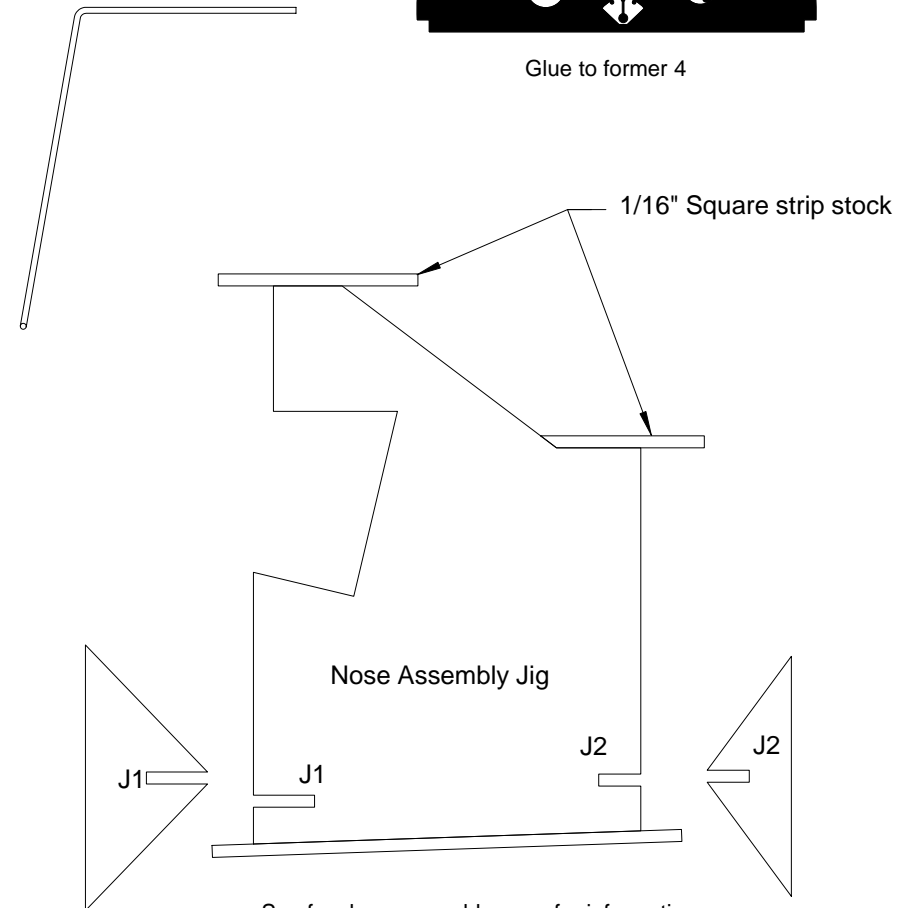

See fuselage assembly page for information on using the nose assembly jig.

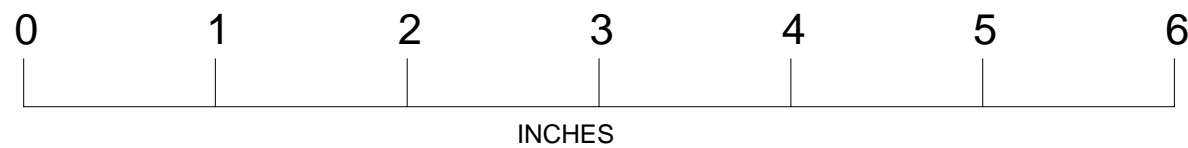
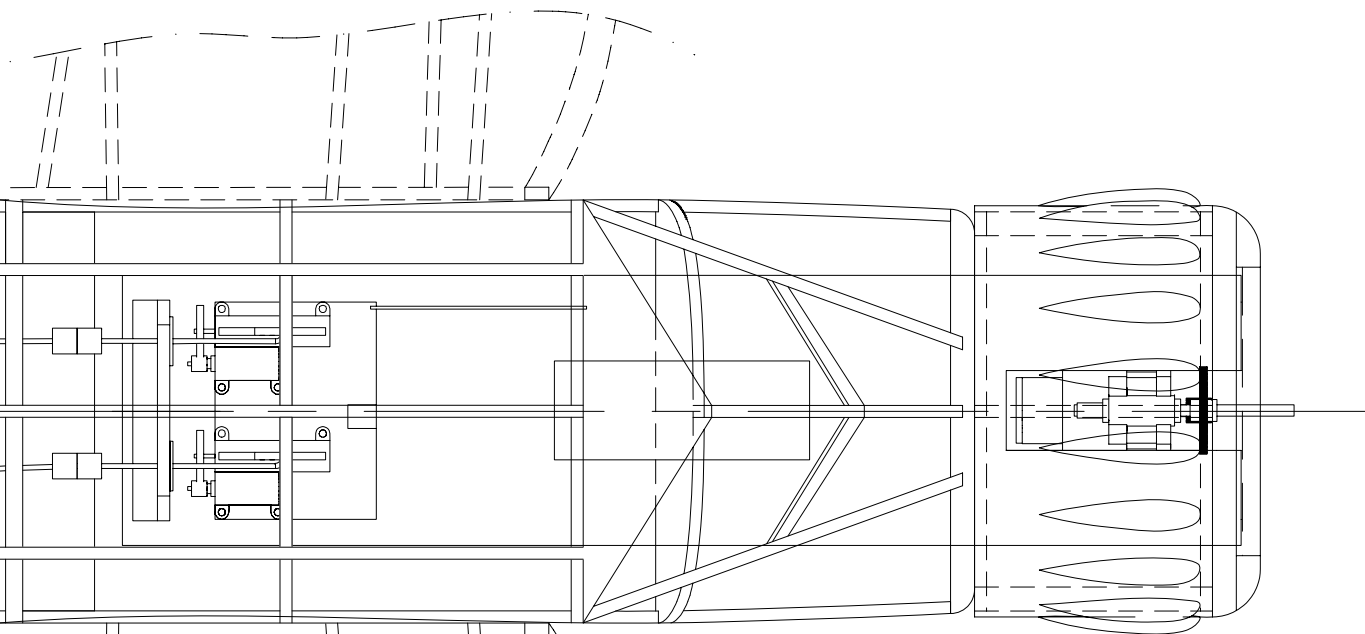

# Comet Stinson Reliant

For Radio Control

Wingspan - 25"

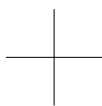



Wing strut - make from 1/16"x1/8" strip stock. Sand to streamline cross section and trim to fit.

Wing strut mount pad

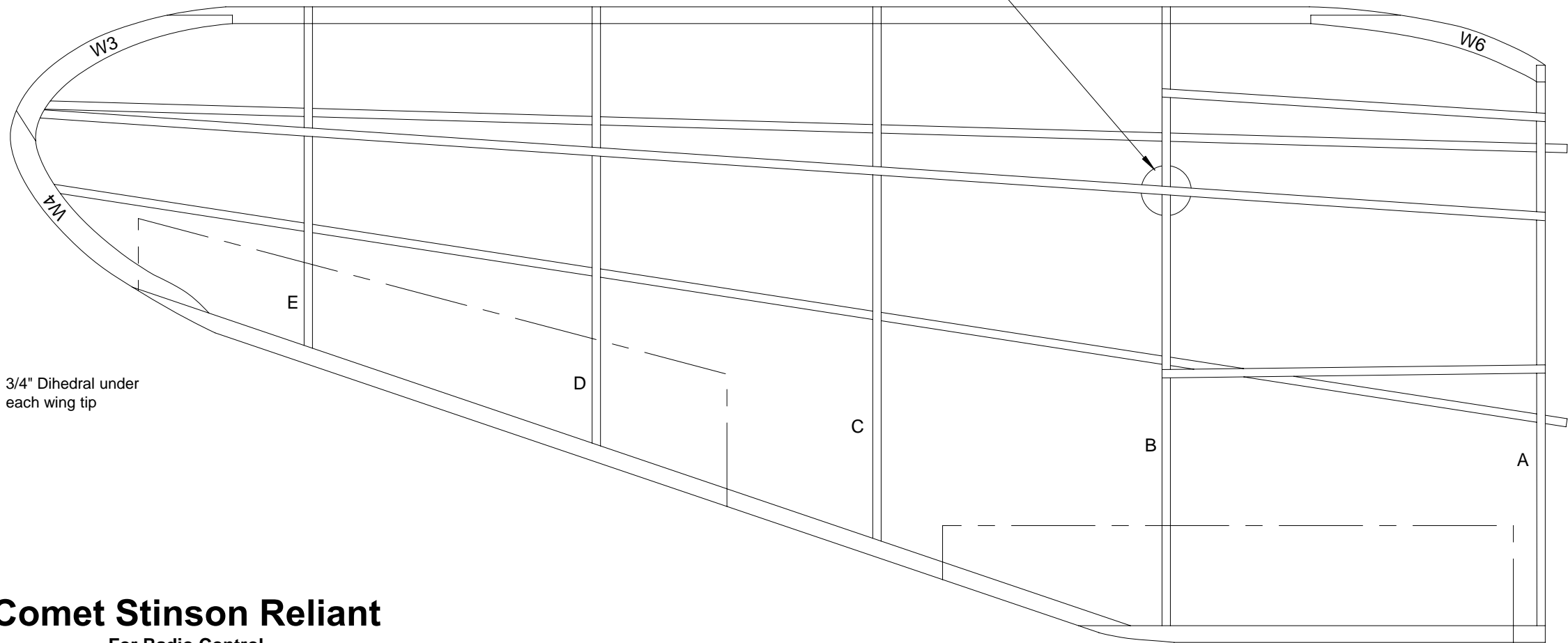

3/4" Dihedral under each wing tip

# Comet Stinson Reliant

For Radio Control

Wingspan - 25"

CAD Drawing by Paul Bradley

Sheet 5 of 12

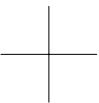
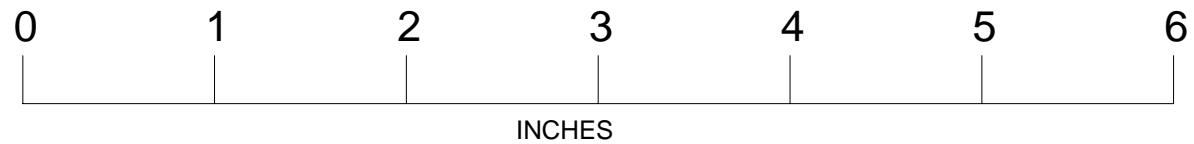

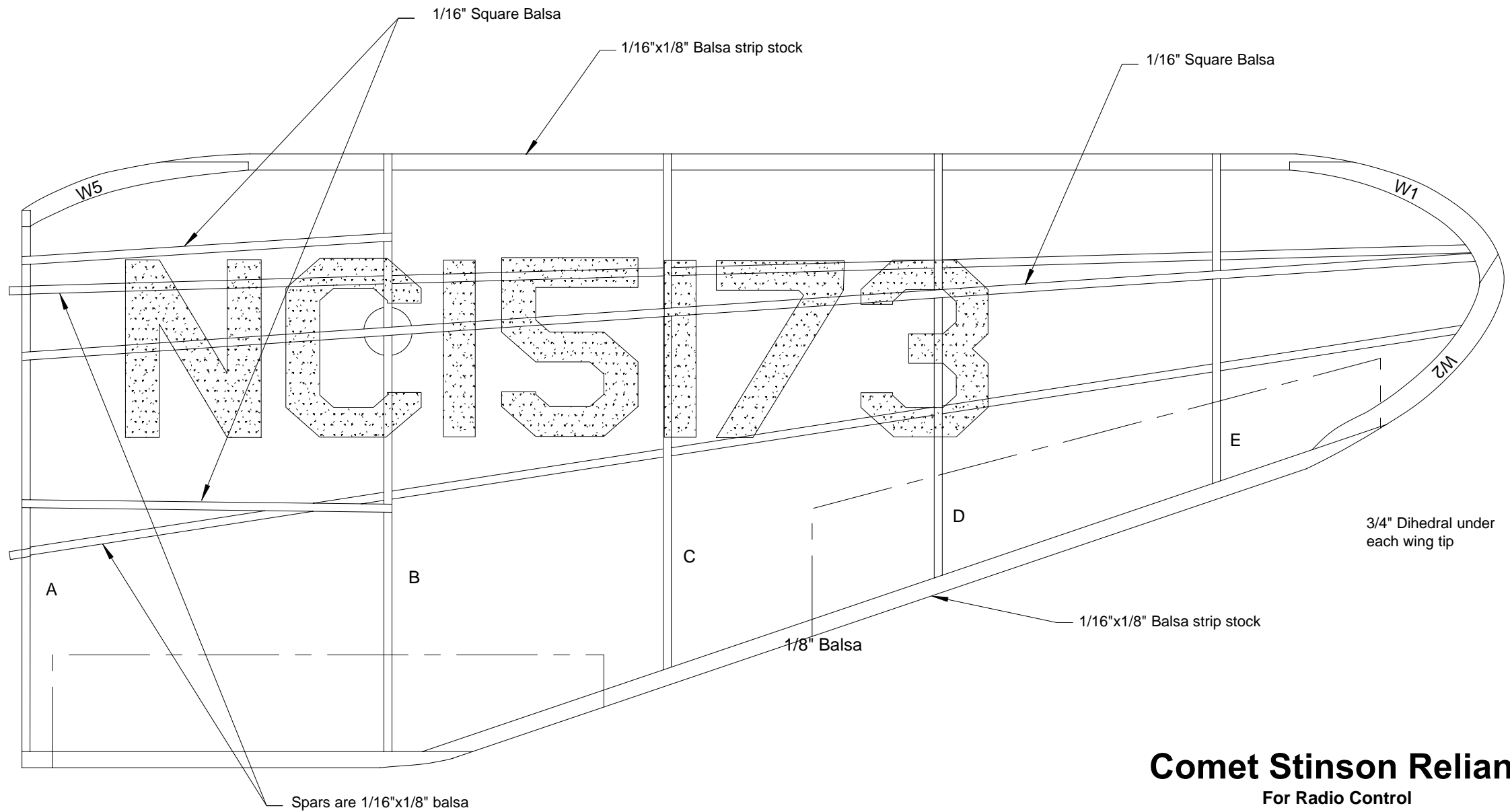
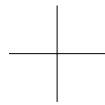

# Comet Stinson Reliant

For Radio Control

Wingspan - 25"

CAD Drawing by Paul Bradley

Sheet 6 of 12

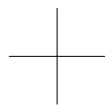
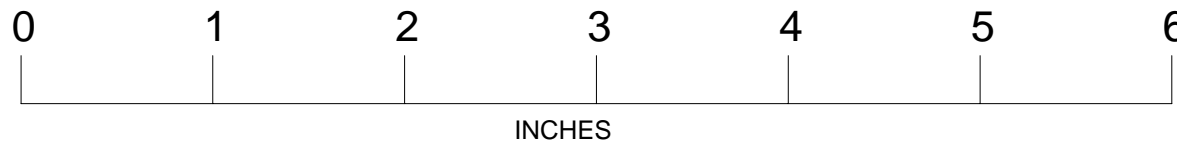

## FUSELAGE ASSEMBLY STEPS

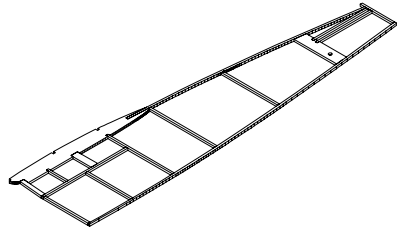

Step 1. Assemble each side over the plan. Do not include the structure forward of the cabin.

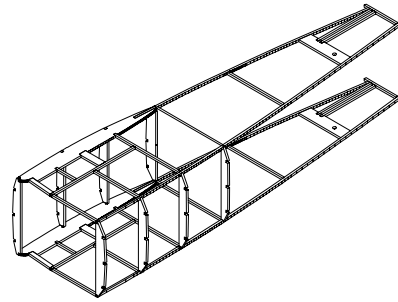

Step 2. Using formers 5 through 8 assemble the sides as shown. Make sure everything is square.

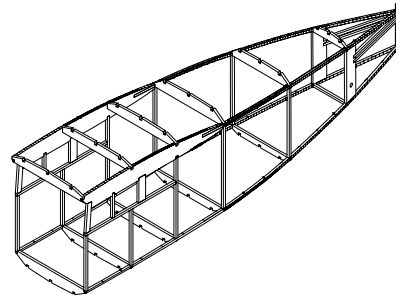

Step 3. Sand the rear of the fuselage sides on the inside face to a taper so when joined the thickness will be 1/16". Glue the fuselage sides together at the rear and then add formers 9 and 10.

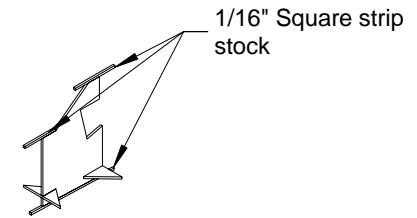

Step 4. Assemble the jig that is used in the assembly of the fuselage nose. Use 1/16" square strip stock for keys on the jig as shown.

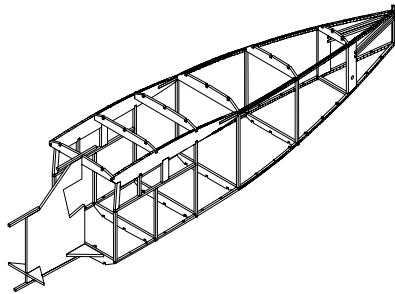

Step 5. Attach the jig to the fuselage as shown. The keys fit in the center notches of formers 5T and 5B. Use pins to hold the jig in place.

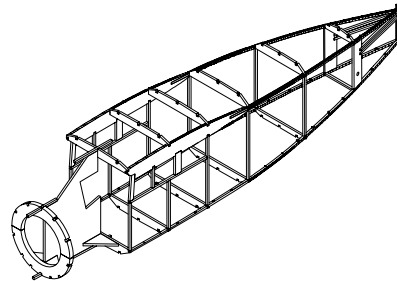

Step 6. Place former 3 on the jig using the keys in the top and bottom notches as alignment guides. Hold the former to the jig with a pin.

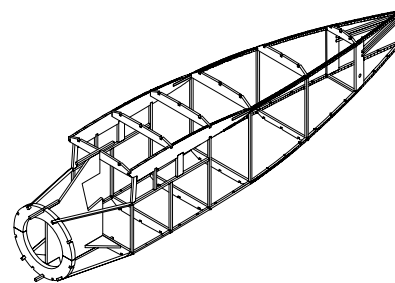

Step 7. Add the pieces of 1/16" strip stock shown. These pieces will set former 3 in place.

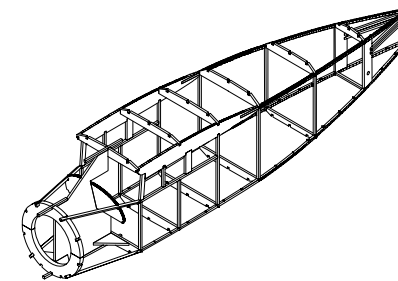

Step 8. Place former 4 on the jig and in contact with the top two longerons that had been installed. The jig sets the former at the proper angle. It will be necessary to adjust the two former notches to get a good fit.

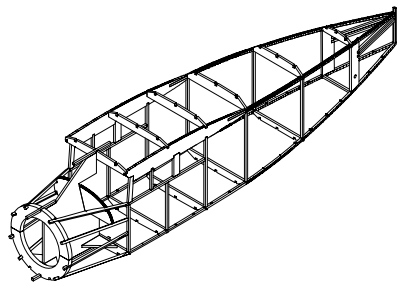

Step 9. Add the remaining side stringers to the nose.

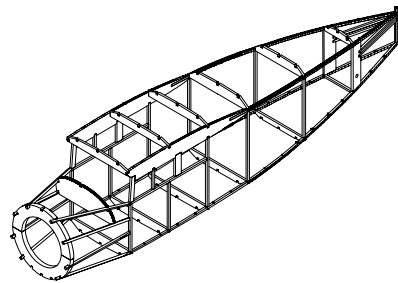

Step 10. Remove the jig. Removing the keys from the top of the jig will allow the jig to be extracted from the bottom of the fuselage.

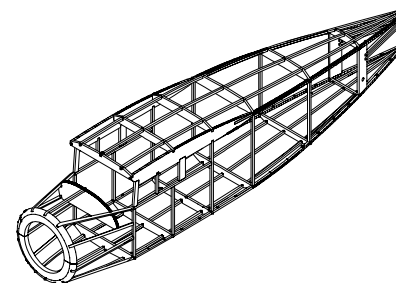

Step 11. Add the top and bottom stringers. Trim the stringers at the nose flush with former 3. Sand the edge of former 3 to a radius.

# Comet Stinson Reliant

Wingspan - 25"

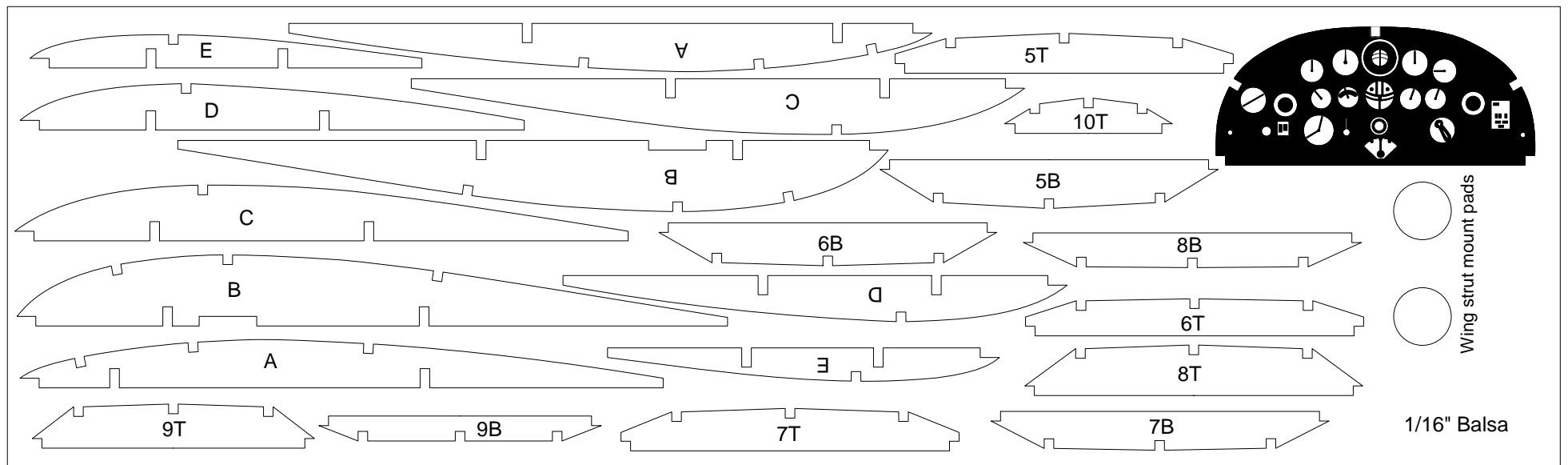
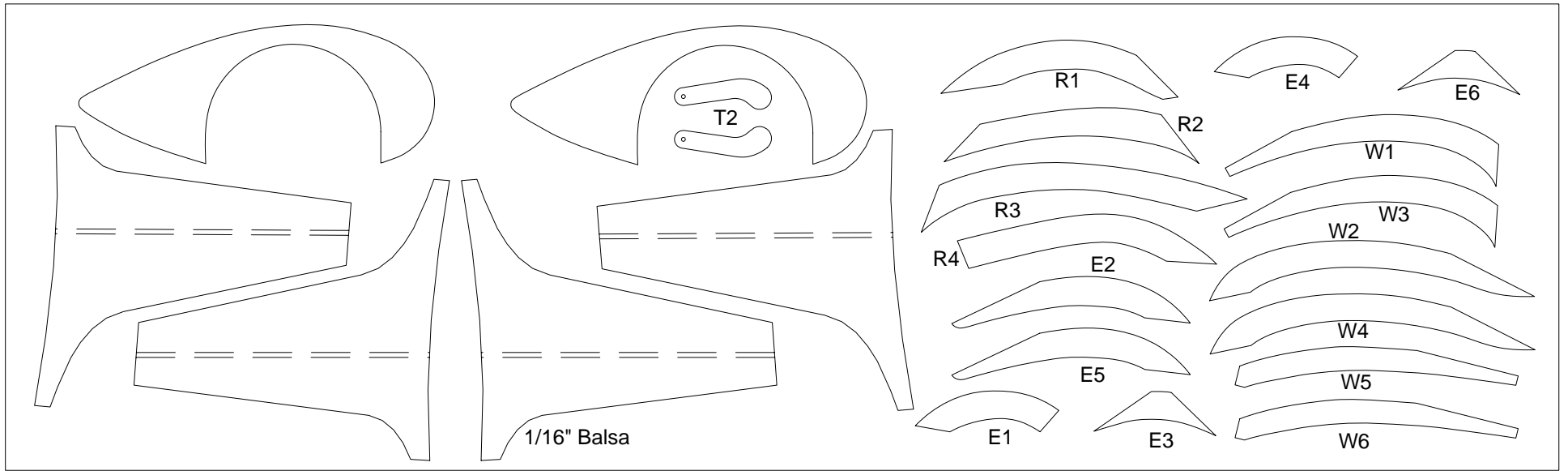

# Comet Stinson Reliant

For Radio Control

Wingspan - 25"

CAD Drawing by Paul Bradley

Sheet 8 of 12

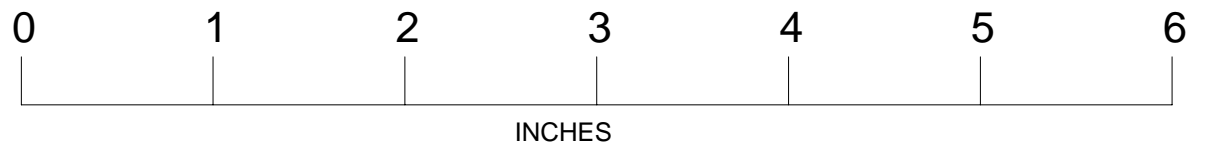





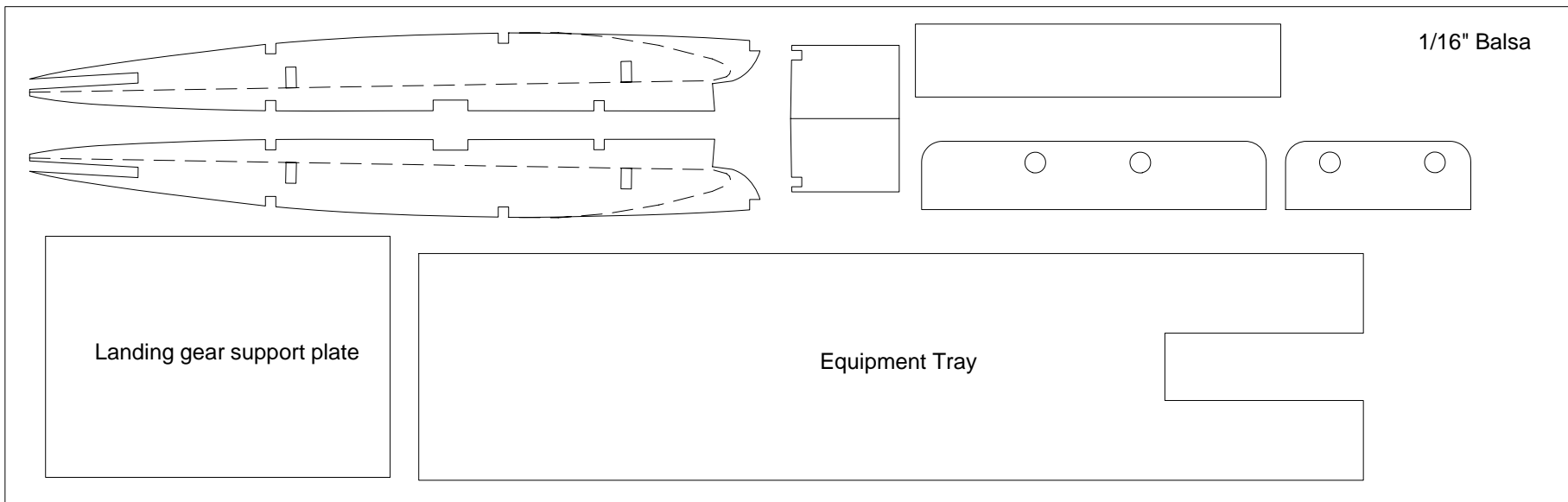
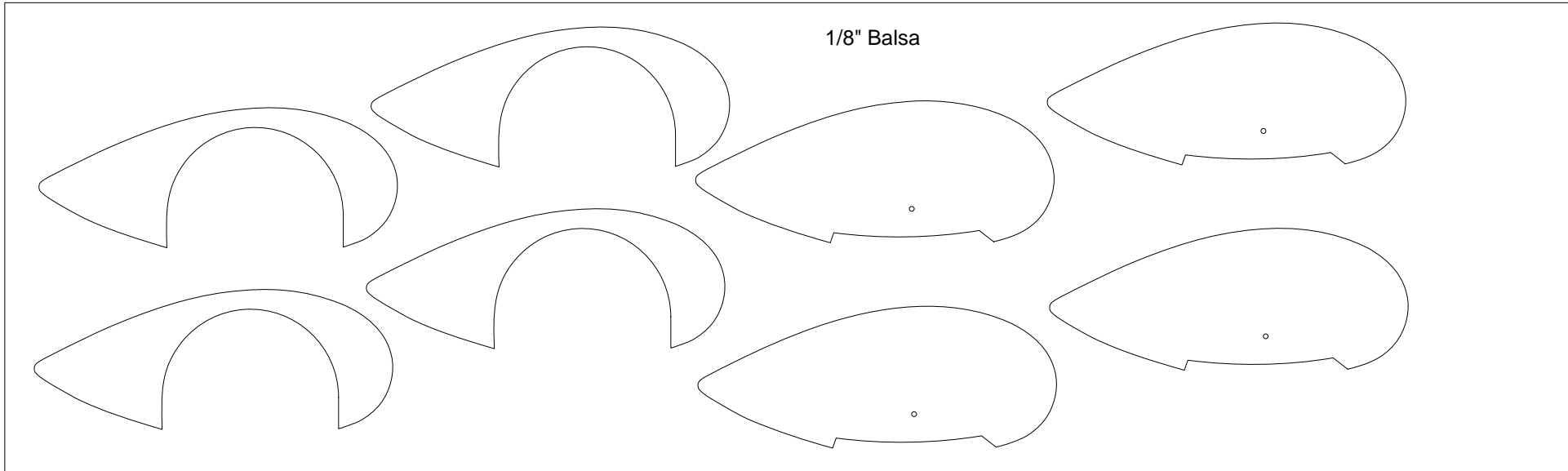

# Comet Stinson Reliant

For Radio Control

Wingspan - 25"

CAD Drawing by Paul Bradley

Sheet 10 of 12

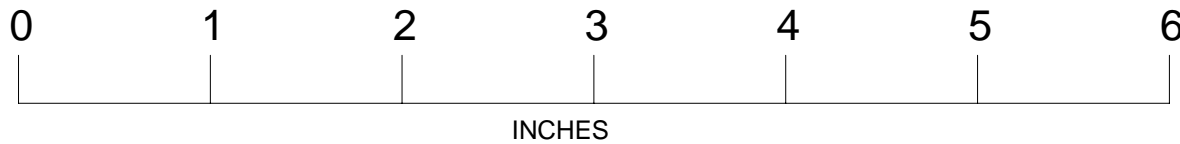

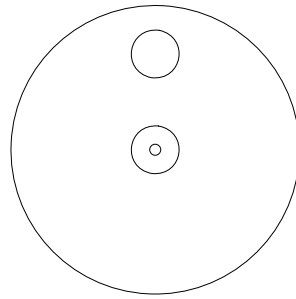
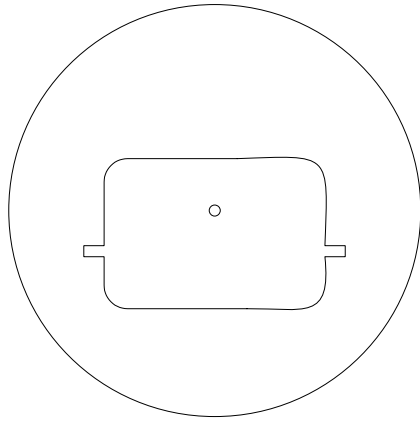

Nose Plug - 1/32" Plywood

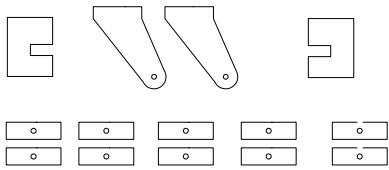

Wheel Cores

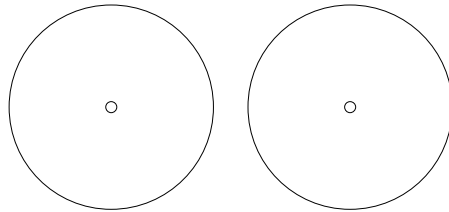

1/64" Plywood

# Comet Stinson Reliant

For Radio Control

Wingspan - 25"

CAD Drawing by Paul Bradley

Sheet 11 of 12

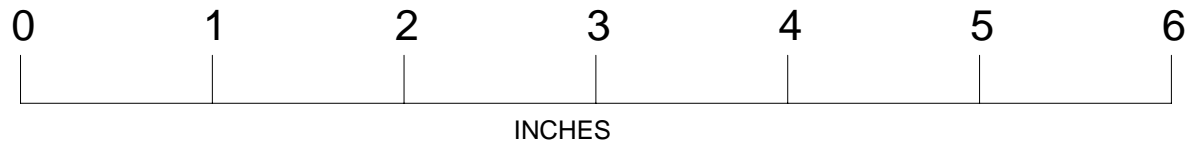

# EQUIPMENT INSTALLATION NOTES

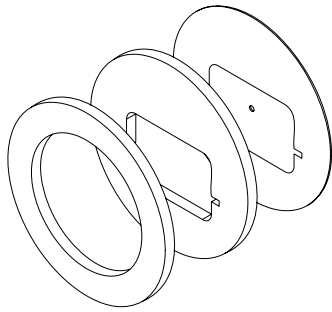

THE COWL NOSE RING IS MADE FROM TWO LAYERS OF 1/8" Balsa AND ONE LAYER OF 1/64" PLYWOOD IN THE ARRANGEMENT SHOWN. DO NOT REMOVE THE CENTER PLUG FROM THE PLYWOOD PIECE UNTIL AFTER SHAPING. USE THE CENTER HOLE IN THE PLYWOOD PIECE TO SECURE THE ASSEMBLY IN A DREMEL TOOL OR ELECTRIC DRILL. TURN THE ASSEMBLY AND SHAPE THE RADIUS. AFTER SHAPING THE PLYWOOD CENTER PLUG CAN BE REMOVED.

1/4" X 1/16" MAGNET GOES HERE

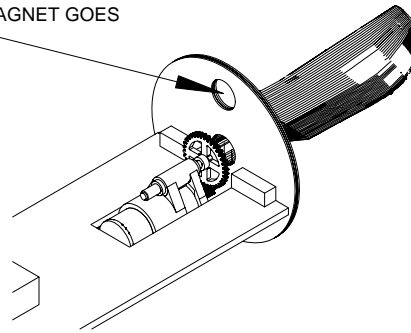

THE EQUIPMENT TRAY RETAINING RING IS MADE FROM THREE LAYERS OF 1/64" PLYWOOD. INSTALL THE RETAINING RING AFTER THE MOTOR HAS BEEN INSTALLED. USE 1/8" SQUARE Balsa STRIPS TO REINFORCE THE JOINT. THE MOTOR IS INSTALLED FROM THE BOTTOM OF THE EQUIPMENT TRAY. BRASS SCREWS (0-80) ARE A GOOD CHOICE FOR RETAINING THE MOTOR. A 1/4" DIAMETER BY 1/16" THICK MAGNET GOES IN THE HOLE IN THE TOP OF THE RETAINING RING.

1/64" PLYWOOD LOCATOR  
PUSHROD SUPPORT

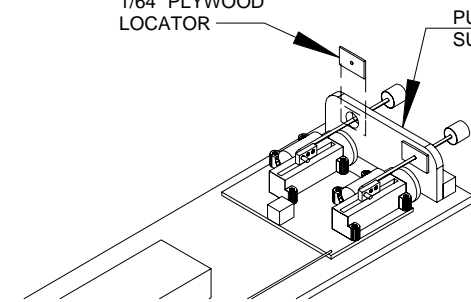

THE RECEIVER BRICK IS INSTALLED AT THE REAR OF THE EQUIPMENT TRAY. THE PUSHROD SUPPORT IS INSTALLED AS SHOWN. USE A PIECE OF 1/8" SQUARE Balsa STRIP TO REINFORCE THE JOINT. EACH PUSHROD IS SLIPPED THROUGH THE HOLES IN THE SUPPORT. A 1/64" PLYWOOD LOCATOR IS THEN PLACED ON EACH PUSHROD BEFORE THE PUSH ROD IS ATTACHED TO THE SERVO OUTPUT ARM. DO NOT GLUE THE PLYWOOD LOCATOR PIECES UNTIL THE ASSEMBLY IS MATED TO THE PUSHRODS IN THE FUSELAGE. WHEN THE PUSHRODS ARE IN CONTACT WITH THE FUSELAGE PUSHRODS THE LOCATOR PIECES CAN BE GLUED TO THE SUPPORTS. BE VERY CAREFUL NOT TO GET GLUE ON THE PUSHRODS.

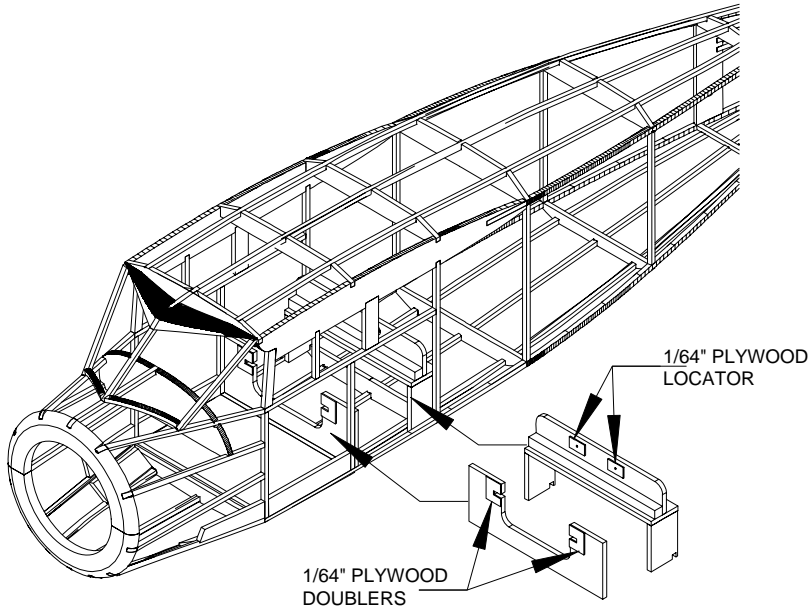

THE REAR SUPPORT FOR THE EQUIPMENT TRAY AND THE FORWARD SUPPORT FOR THE FUSELAGE SIDE OF THE PUSHRODS ARE SHOWN HERE. THESE ASSEMBLIES ARE LOCATED IN THE FUSELAGE AS SHOWN. AS WAS NOTED FOR THE TRAY SIDE PUSHRODS, DO NOT GLUE THE 1/64" PLYWOOD LOCATORS UNTIL THE EQUIPMENT TRAY IS IN POSITION AND THE PUSHRODS ARE IN CONTACT. WHEN INSTALLING THE FUSELAGE PUSHRODS PLACE A 1/4" OF 1/8" DOWEL WITH A CENTER HOLE DRILLED ON EACH PUSHROD. DO NOT GLUE THE DOWELS. FOR PUSHROD MATERIAL .025" CARBON ROD IS RECOMMENDED. SUPPORTS FOR THE PUSHRODS CAN BE LOCATED BETWEEN THE FUSELAGE UPRIGHTS. USE 1/8" DIAMETER HOLES IN THE PUSHROD SUPPORTS AND PLYWOOD LOCATORS. AFTER THE PUSHRODS ARE IN PLACE INSERT THE EQUIPMENT TRAY. POWER UP THE RECEIVER AND LOOK AT THE FOR AND AFT STROKE OF THE PUSHRODS. MOVE THE DOWELS ON THE FUSELAGE MOUNTED PUSHRODS SO WHEN THE PUSHRODS ARE MOVED FULLY FORWARD THE DOWELS JUST COME INTO CONTACT WITH THE PUSHROD SUPPORT PIECE. GLUE THE DOWELS IN THAT POSITION ON THE PUSHRODS. THE DOWELS SERVE AS CONTROL STOPS WHEN THE EQUIPMENT TRAY IS REMOVED.

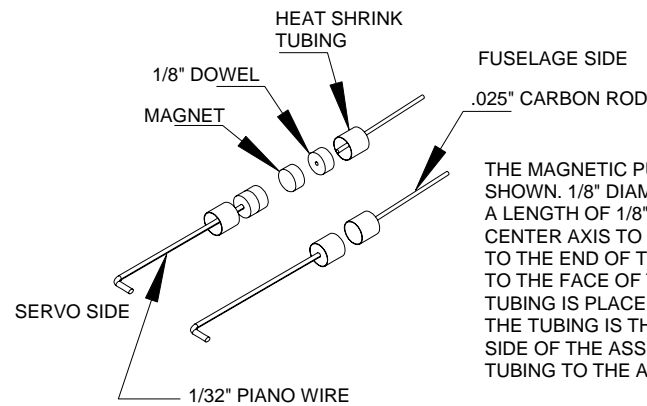

FUSELAGE SIDE

.025" CARBON ROD

THE MAGNETIC PUSHROD CONNECTORS ARE SET UP AS SHOWN. 1/8" DIAMETER BY 1/8" THICK MAGNETS ARE USED. A LENGTH OF 1/8" DOWEL IS DRILLED THROUGH THE CENTER AXIS TO FIT THE PUSHROD. THE DOWEL IS GLUED TO THE END OF THE PUSHROD. A MAGNET IS THEN GLUED TO THE FACE OF THE DOWEL. A LENGTH OF HEAT SHRINK TUBING IS PLACED OVER THE MAGNET/DOWEL ASSEMBLY. THE TUBING IS THEN SHRUNK. A DROP OF CA FROM EACH SIDE OF THE ASSEMBLY HELPS SECURE THE HEAT SHRINK TUBING TO THE ASSEMBLY.

## Comet Stinson Reliant For Radio Control

Wingspan - 25"

CAD Drawing by Paul Bradley

Sheet 12 of 12