

There are several notes I need to provide to aid you with the enclosed package. The original kits used 1/16" balsa. Since I wanted to print these directly on balsa sheet I developed the parts for 1/32" balsa sheet. As a result, some of the parts have been drawn to allow for cross grain laminations. The fuselage formers are a good example. This works fine as long as you are using 1/32" sheet stock.

If you do not have a printer that will allow direct printing on the balsa, consider using the iron on T-shirt transfer paper layouts provided via the paramodels.com web site. This material can be printed on any color inkjet printer. You can then transfer the part graphics to balsa sheet of any thickness using a regular clothes iron.

I like to use a removable nose for winding. The parts have been drawn with this in mind. The nose former has been drawn so a removable nose plug can be used. The FrogFlite series of models provides a piece of 1/4" balsa for the nose block. The piece of balsa had to be cut to shape and then sanded to the nose profile. A template has been provided to aid cutting the nose block to the shape of the nose.

The kit included reinforcements for the rear motor peg. The parts in this package include the same rear motor peg reinforcement parts. The only difference is two sets of those parts are included to allow for models build from 1/32" balsa. This has proven to be plenty strong for a fully wound motor of 1/8" Tan rubber. A piece of 3/32" OD aluminum tubing is used for the rear motor peg.

A few minor structural changes were made for the reproduction model. Fuselage partial formers were added where the top sheeting joints occur. This makes assembly of the top sheeting much easier. The building notes also suggest assembling the wing halves before the wing is attached to the fuselage. The plan calls for each wing half to be individually glued to the fuselage. That makes it much harder to get the wing assembled and square to the fuselage.

The plan suggests sanding the wheel pants to a streamlined shape. The original kit had almost no markings on the wheel pant parts so sanding would be fine. The reproduction parts have color applied to the outside faces of the wheel pants. To retain the colors it is suggested the wheel pants not be sanded to a streamlined shape. This will make no difference to the flying qualities of the model.

The markings used in the original Ryan PT-20 kit were retained for this reproduction package. Some enhancements are included. For example, the original kit parts only had one color applied to the balsa sheets. Where the kit left the balsa bare the appropriate color was added to the reproduction model parts.

I do hope you build and enjoy a model from this plan package.

Paul Bradley

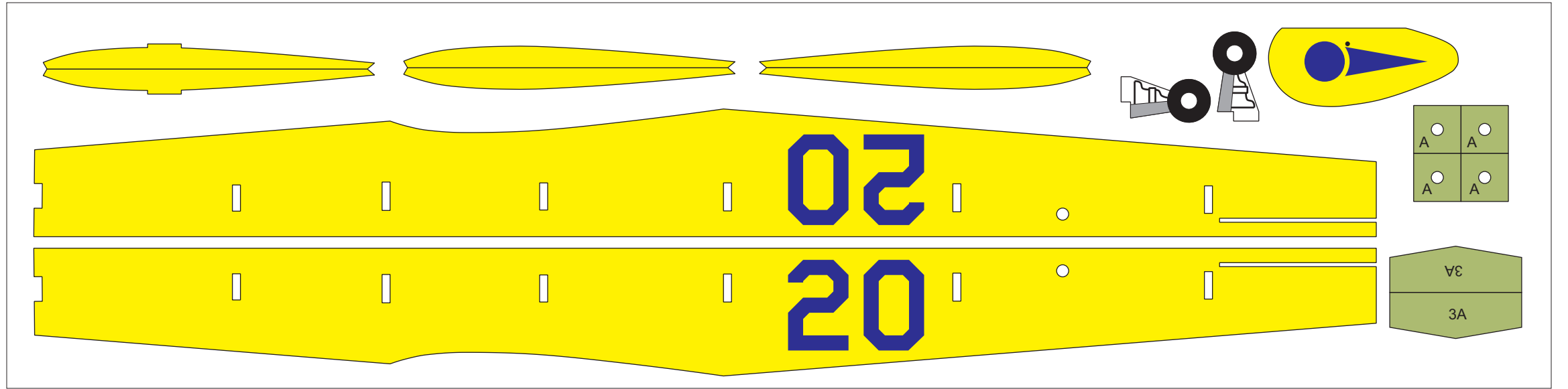

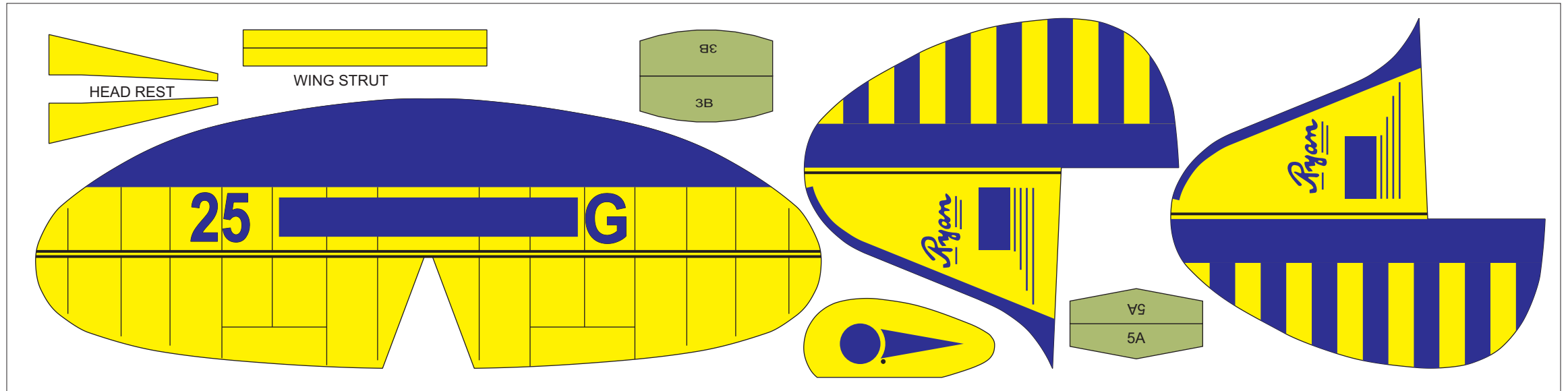

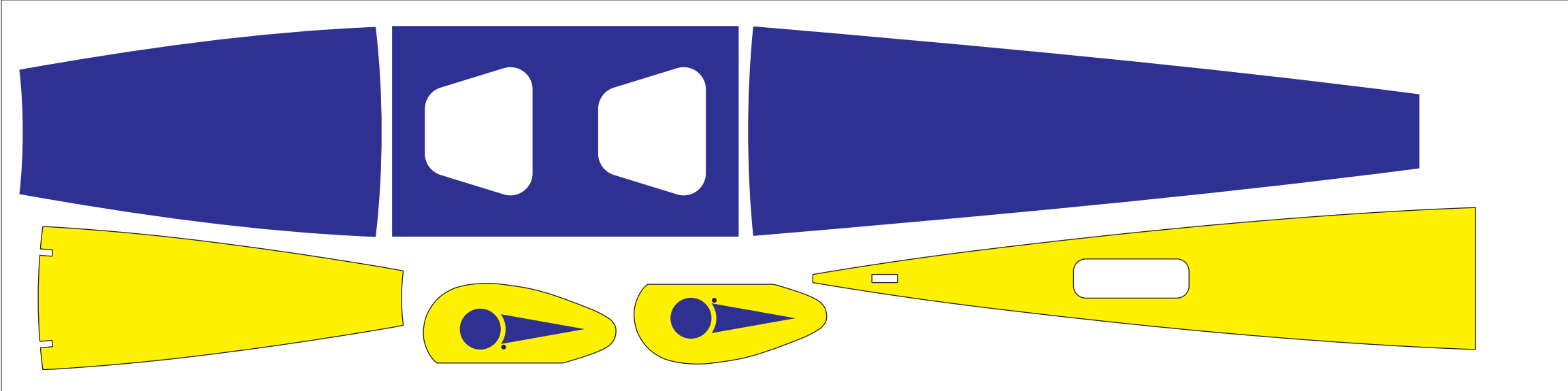

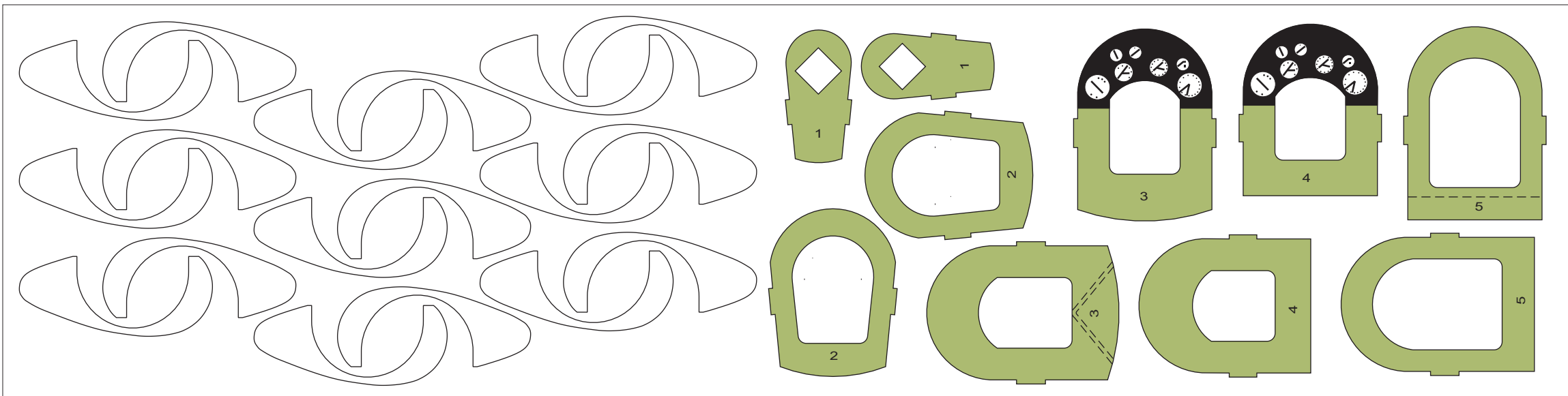

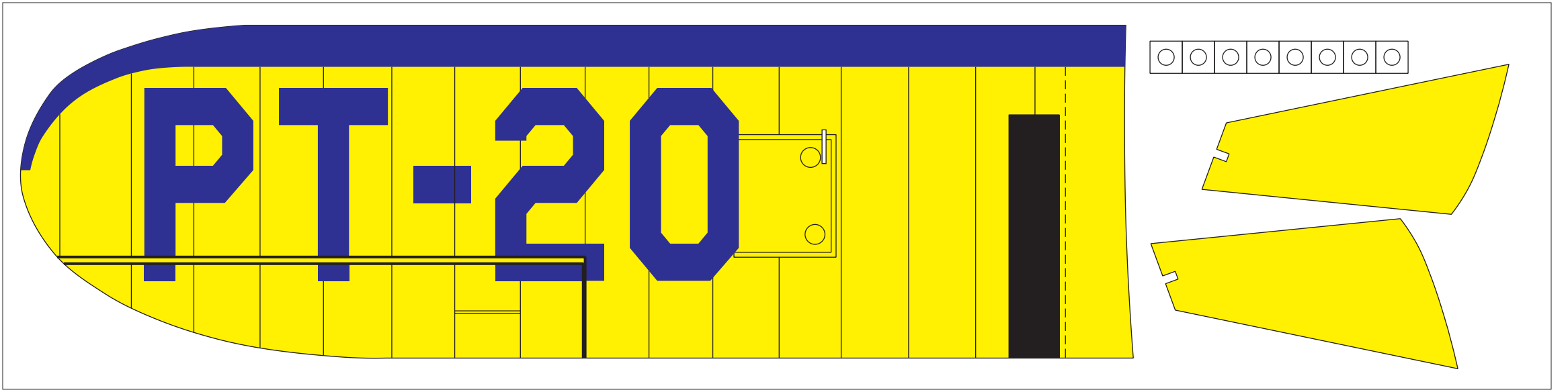

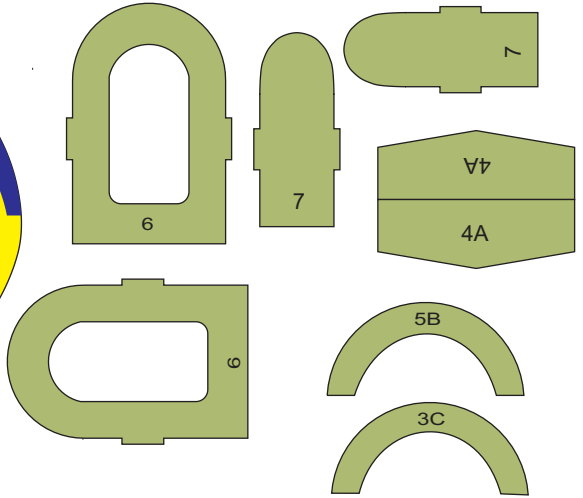

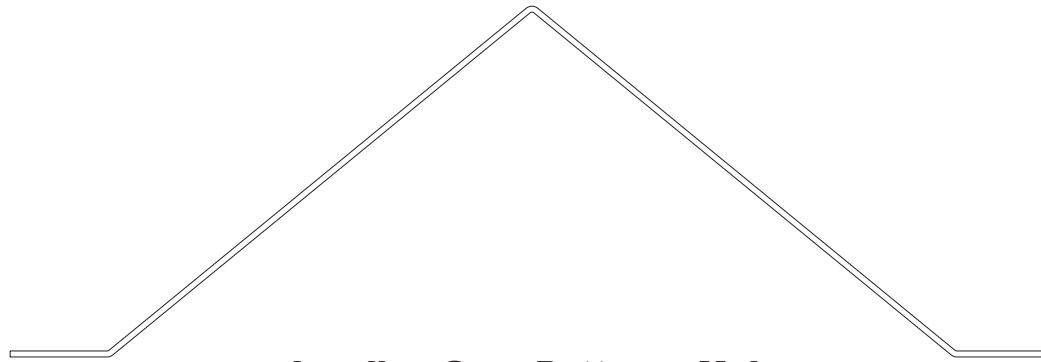

**Landing Gear Pattern - Make
from .025 music wire. Use two 3/4" Wheels**



Windshields

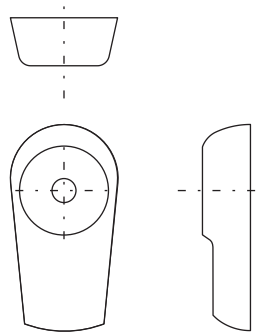

Nose Block - Make from 1/4" balsa

FrogFlite Ryan PT-20

Modifications to Original

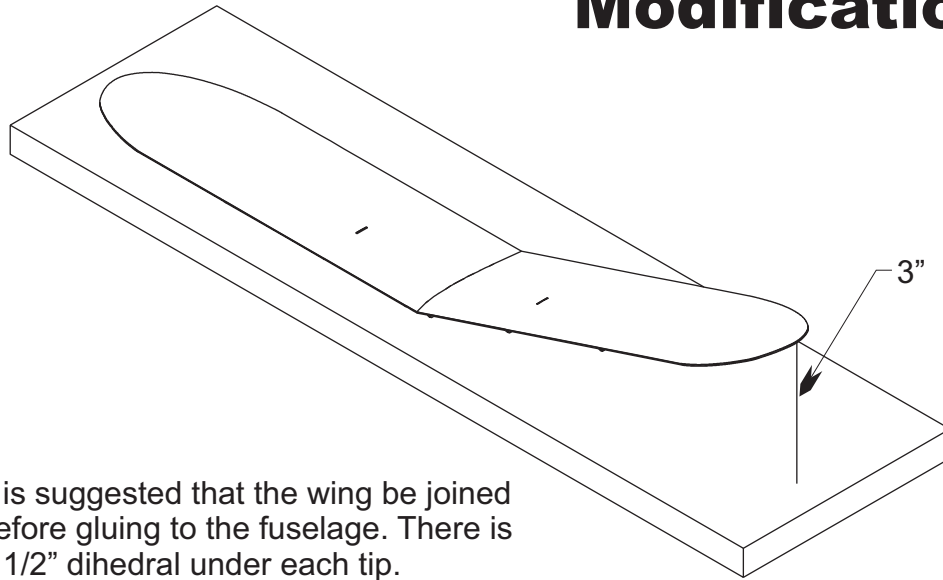

It is suggested that the wing be joined before gluing to the fuselage. There is 1 1/2" dihedral under each tip.

Use as many center laminations as is necessary to be slightly wider than the wheel

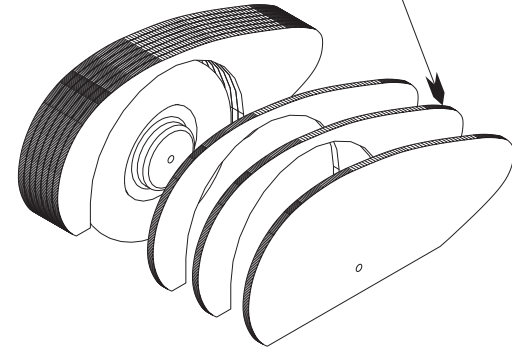

To maintain the printed colors on the outside laminations, do not sand to a streamlined shape.

Arrangement for the Wheel Pants (Spats)

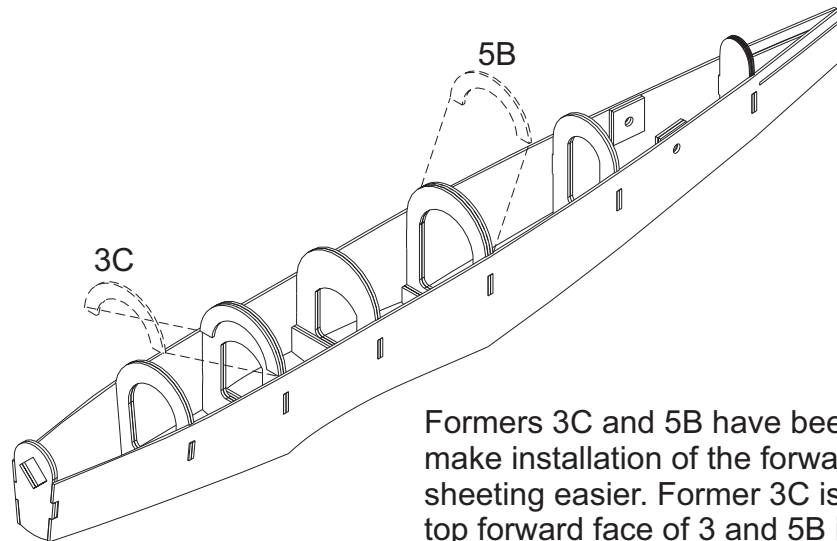

Formers 3C and 5B have been added to make installation of the forward and rear top sheeting easier. Former 3C is glued to the top forward face of 3 and 5B is glued to the rear top face of 5.

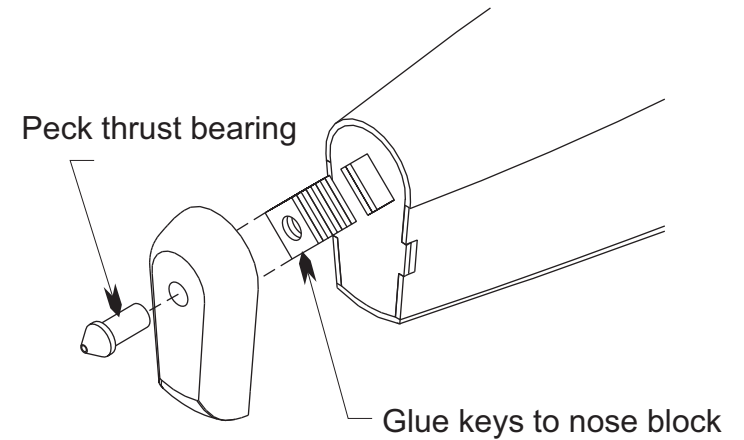

Removable Nose Block Arrangement

FrogFlite Ryan PT-20

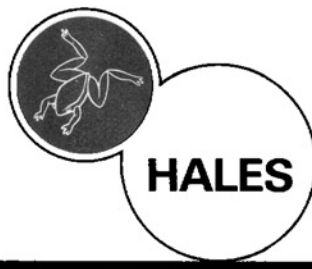
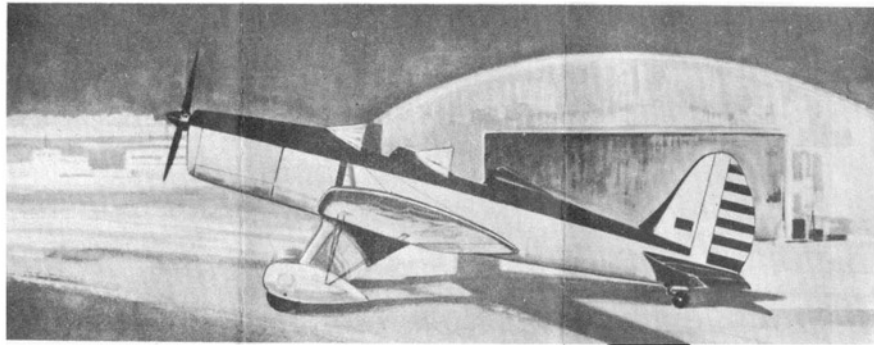

QuickBuild SERIES
RUBBER POWERED FLYING SCALE MODELS

FROGLITE KITS
DESIGNED AND DRAWN BY RON WARRING COPYRIGHT IN ALL COUNTRIES
MANUFACTURED IN ENGLAND BY:
A. A. HALES LIMITED, POTTERS BAR, HERTFORDSHIRE

PT-20 TRAINER

YOUR ASSEMBLY INSTRUCTIONS

IMPORTANT: CHECK AND IDENTIFY YOUR KIT PARTS

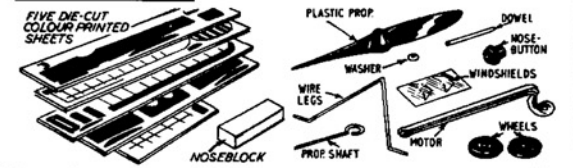

- 1 All balsa parts are die cut to shape reqd. except noseblock.
- 2 Check the remaining kit parts supplied against this.

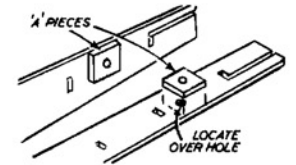

- 3 Cement on 'A' pieces on the inside each of fuselage side.

<p>4 Assemble fuselage sides on formers 3, 4, 5. Keep square.</p>	<p>5 Cement sides together at rear and fit formers 6 and 7.</p>	<p>6 Now join sides accurately at nose with formers 1 and 2.</p>	<p>7 Now cement former braces 3a, 4a and 5a in place.</p>	<p>8 Bottom panel cements in pos'n. Round off edge when set.</p>	<p>9 Run lines of cement across underside of each wing panel.</p>	<p>10 Cement on all wing ribs and pin down as shown until set.</p>		
<p>11 Cement left wing in position accurately holding with pins.</p>	<p>12 Cement on other wing panel after checking centre joint.</p>	<p>13 Cement wire legs to former 3 and lock in position with 3b.</p>	<p>14 Cement balsa legs to ribs and align wire legs correctly.</p>	<p>15 Cement on lower cowling and trim off flush when set.</p>	<p>16 Add cellulose tape strips—then crack-bend panels.</p>	<p>17 Cement cockpit coaming in place after checking fit.</p>		
<p>18 Trim to cowling to fit—then cement in place.</p>	<p>19 Trim rear decking to fit—then cement in place.</p>	<p>20 Drill noseblock, cement in place. Shape when set.</p>	<p>21 Cement on tailplane and fin. Check for squareness.</p>	<p>22 Add tailwheel—then clean up fuselage edges by sanding.</p>	<p>ALL PARTS ARE PRE-DECORATED & COMPLETED MODEL DOES NOT REQUIRE COLOUR. COLOUR DOPE MAY BE USED FOR TOUCHING UP AS REQD.</p> <p>NOTE: CERTAIN DEPARTURES FROM TRUE SCALE OUTLINE HAVE BEEN NECESSARY TO ENSURE GOOD FLYING PERFORMANCE.</p>			
<p>23 Assemble spats round wheel. Carve—then cement to leg.</p>	<p>24 Cement on wing struts, add thread bracing and windshields.</p>	<p>25 Assemble prop. etc. on shaft. Bend over end of shaft.</p>	<p>26 Rubber band motor loops over propeller shaft.</p>	<p>27 Assemble motor and prop. ready for test flying.</p>				
<p>CHECK ASSEMBLED MODEL FOR CORRECT ALIGNMENT VIEW FROM REAR</p>	<p>AILERONS BENT UP EQUAL AMOUNTS</p>	<p>BEND ELEVATORS DOWN TO CURE STALL</p> <p>BEND ELEVATORS UP TO CURE DIVE</p> <p>HAND GLIDE OVER LONG GRASS</p>	<p>CORRECT EXCESSIVE TURN BY BENDING RUDDER</p>	<p>INSERT PACKING HERE TO CURE STALL</p> <p>CHECK TRIM UNDER POWER</p>				

FROGFLITE



HALES

Quick Build series
Rubber Powered Flying Scale Models

RYAN PT 20

