

There are several notes I need to provide to aid you with the enclosed package. The original kits used 1/16" balsa. Since I wanted to print these directly on balsa sheet I developed the parts for 1/32" balsa sheet. As a result, some of the parts have been drawn to allow for cross grain laminations. The fuselage formers are a good example. This works fine as long as you are using 1/32" sheet stock.

If you do not have a printer that will allow direct printing on the balsa, consider using the iron on T-shirt transfer paper layouts provided via the [paramodels.com](http://paramodels.com) web site. This material can be printed on any color inkjet printer. You can then transfer the part graphics to balsa sheet of any thickness using a regular clothes iron.

I like to use a removable nose for winding. The parts have been drawn with this in mind. The nose former has been drawn so a removable nose plug can be used. The FrogFlite series of models provides a piece of 1/4" balsa for the nose block. The piece of balsa had to be cut to shape and then sanded to the nose profile. A template has been provided to aid cutting the nose block to the shape of the nose.

The kit included reinforcements for the rear motor peg. The parts in this package include the same rear motor peg reinforcement parts. The only difference is two sets of those parts are included to allow for models build from 1/32" balsa were parts are laminated to be 1/16" in thickness. This has proven to be plenty strong for a fully wound motor of 1/8" Tan rubber. A piece of 3/32" OD aluminum tubing is used for the rear motor peg.

The markings used in the original Piper Pacer kit were retained for this reproduction package. Those markings seem a bit strange for an aircraft like the Piper Pacer as they represent the style of markings used for aerobatic aircraft. I could not find any references to any actual Piper Pacer with markings like those used for the kit model. Some enhancements are included. For example, the original kit parts only had one color applied to the balsa sheets. Where the kit left the balsa bare the appropriate color as shown in the box art was added to the reproduction model parts.

I do hope you build and enjoy a model from this plan package.

Paul Bradley

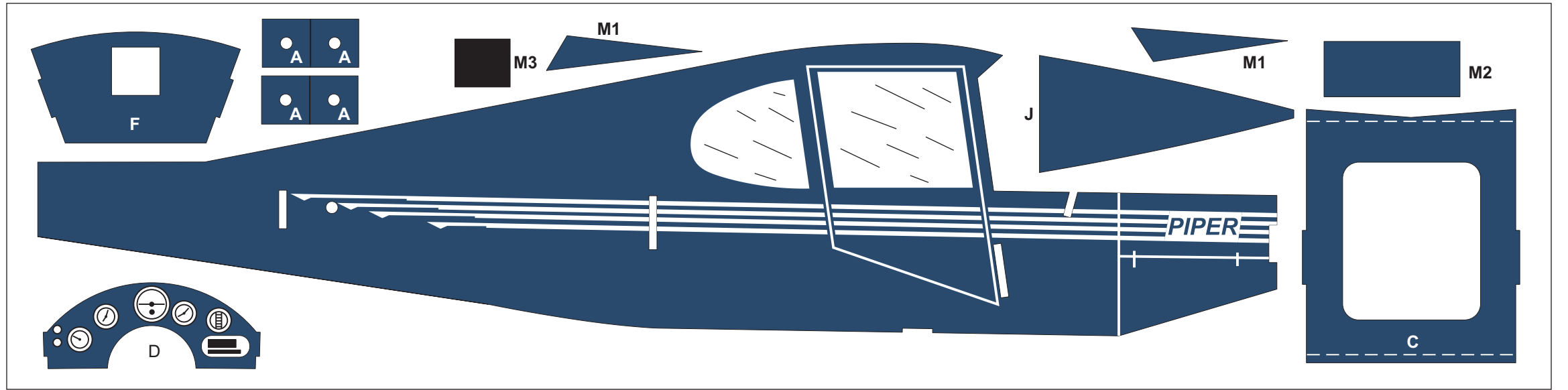

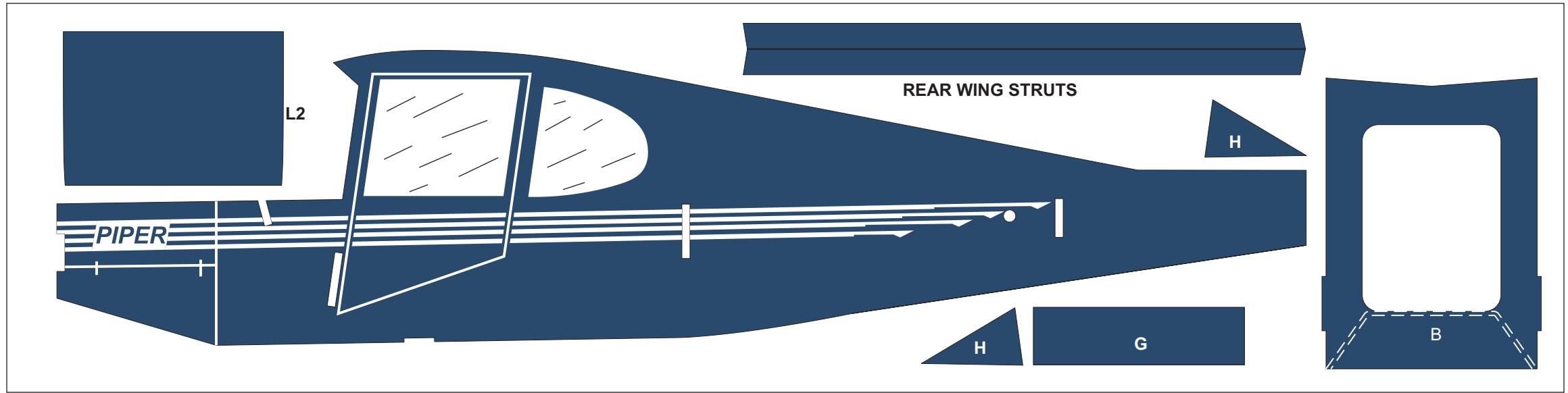

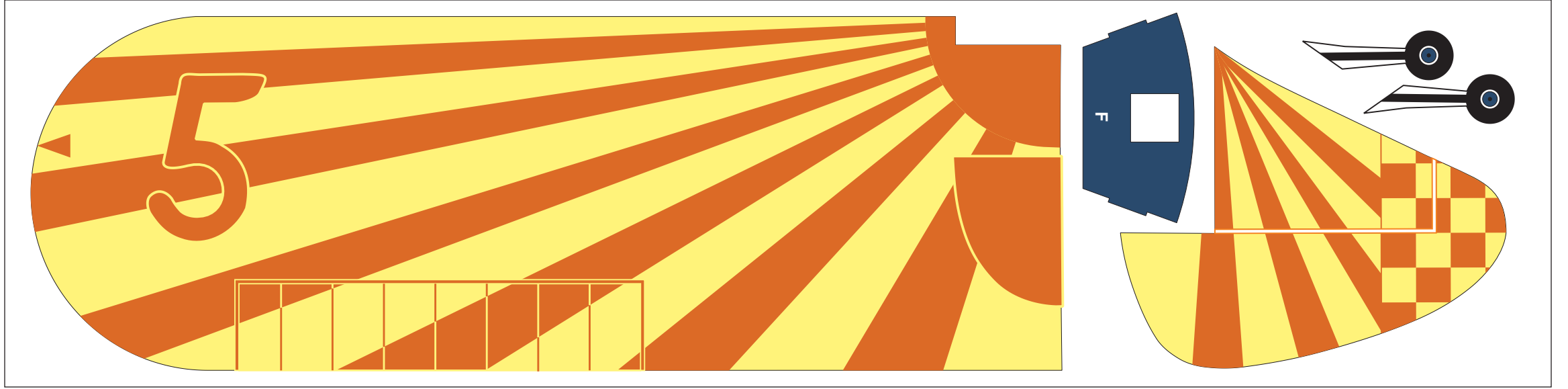



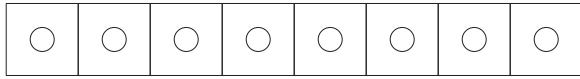

**NOSE BLOCK KEYS**

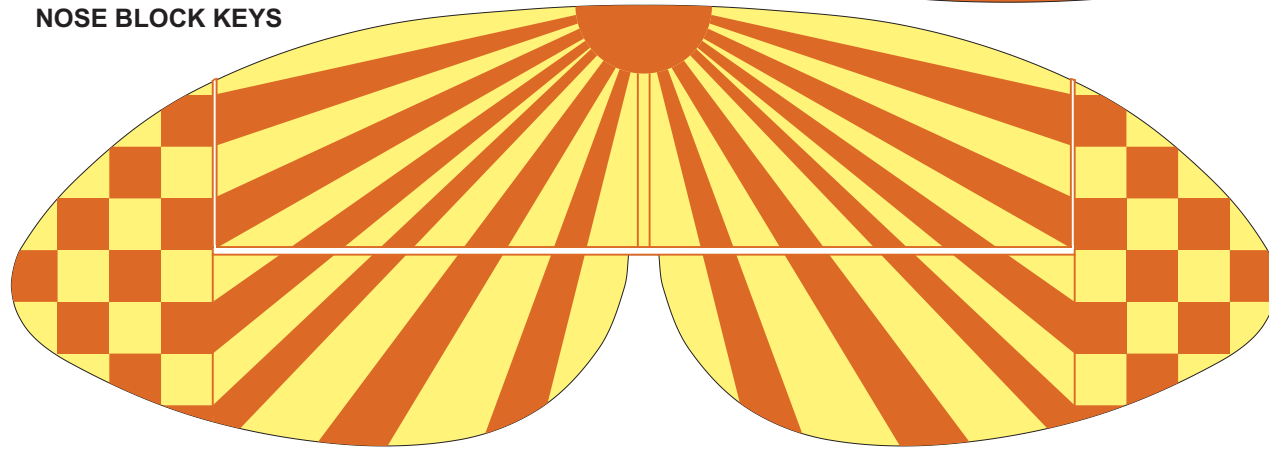

**COWL**

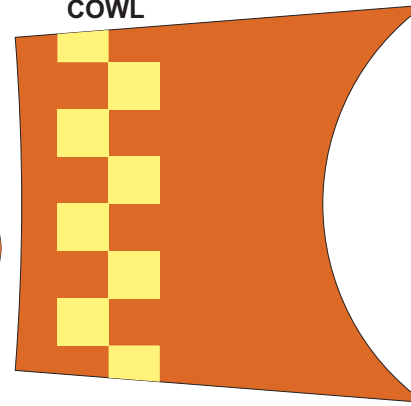

**L3**

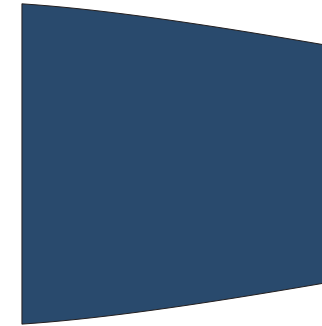

**K**

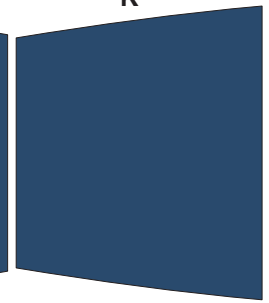

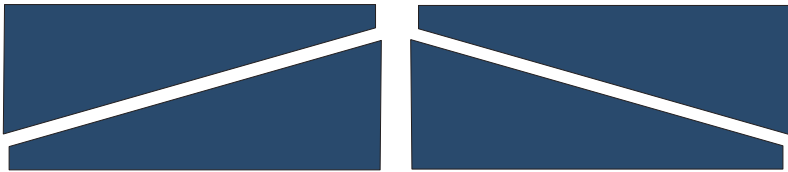

LANDING GEAR COVERS

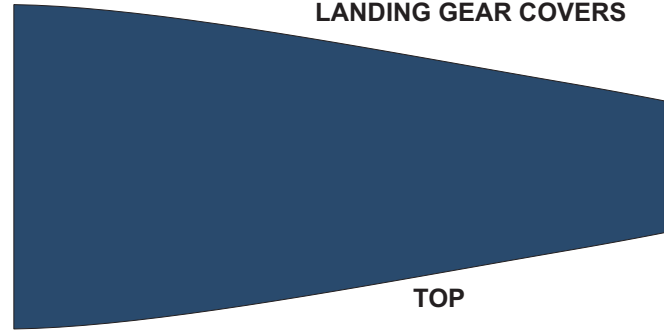

TOP

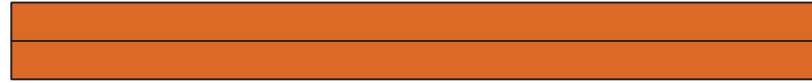

FORWARD WING STRUTS



E

M

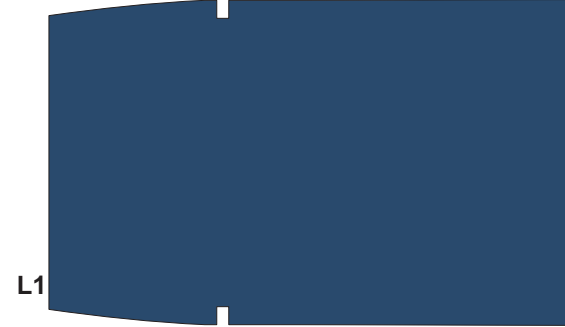

L1

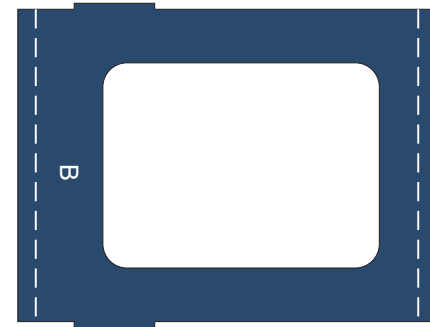

B



C

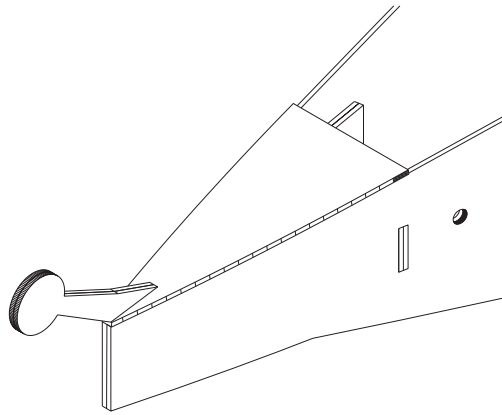

Skip step 6. The built up tail wheel has been replaced with a laminated sheet balsa tail wheel to ease construction. It is glued in place in Step 7 after the bottom sheeting has been installed.



**Landing Gear Pattern - Make from .025 music wire. Use two 3/4" Wheels**

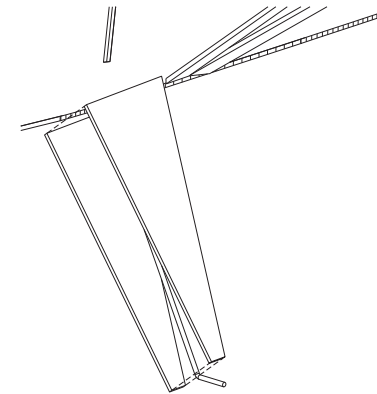

Landing gear leg covers have been provided. They sandwich the wire landing gear legs as shown.

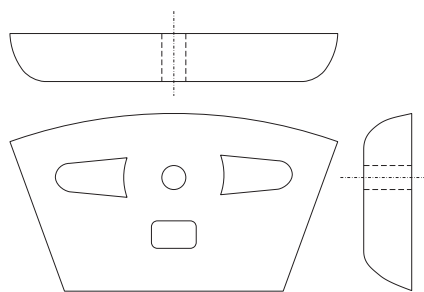

**Nose Block - Make from 1/4" balsa**

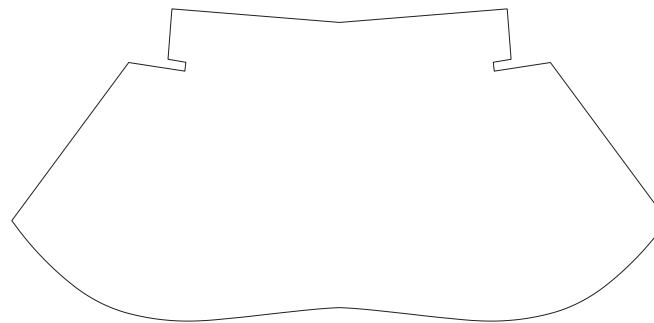

**Windshield Pattern**

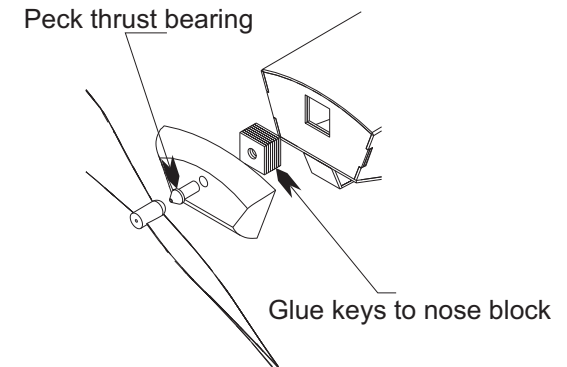

The nose block is removable for stretch winding as opposed to the fixed block shown on the kit plan. The nose block is made from 1/4" balsa. Glue the laminated key block to the rear face of the nose block.

# FrogFlite Piper Pacer



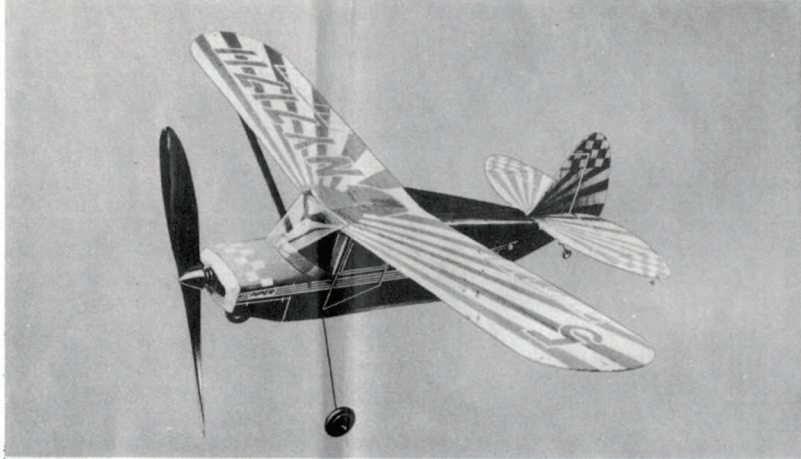

**HALES**

**QuickBuild SERIES**  
RUBBER POWERED FLYING SCALE MODELS

**FROGFLITE KITS**

DESIGNED AND DRAWN BY RON WARRING COPYRIGHT IN ALL COUNTRIES

MANUFACTURED IN ENGLAND BY:

A. A. HALES LTD. HINCKLEY, LEICS.

**PIPER PACER**

**YOUR ASSEMBLY INSTRUCTIONS**

**IMPORTANT: CHECK AND IDENTIFY YOUR KIT PARTS**

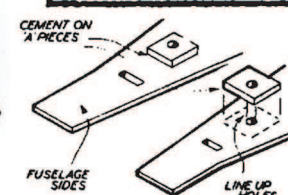
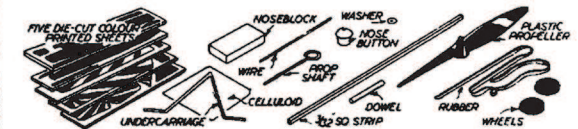

Press out the pre-cut sheet parts—free with a razorblade if necessary. Cement 'A' pieces to inside of fuselage.

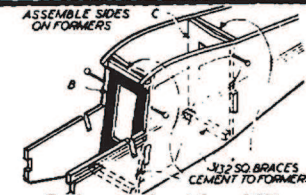

Cut braces to length from 3/32" sq. strip and cement across formers 'B' and 'C' where marked. Assemble sides on 'B' and 'C'.

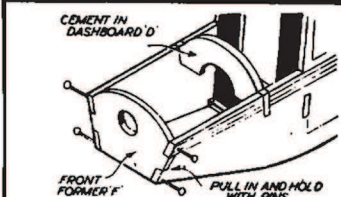

**3** Cement on front former pulling in sides at bottom. Use pins or rubber band to hold. Cement 'D' in slots.

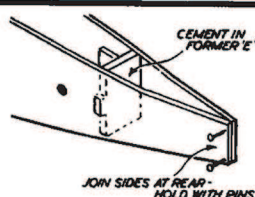

**4** Pull in sides and cement together at rear. Cement in former 'E' and check that fuselage is true and square throughout.

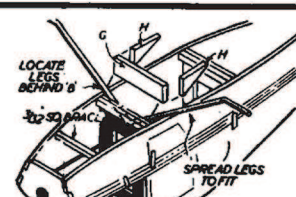

**5** Cut and fit 3/32" sq. brace. Bend wire legs open slightly to fit fuselage. Lock in place with 'G' cementing well. Add H, H.

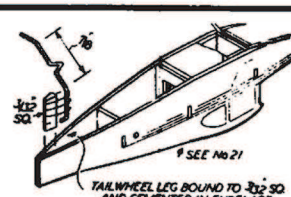

**6** Trim piece of 3/32" sq. to fit inside rear of fuselage. Bend tailwheel leg and bind to 3/32" sq. then cement in place.

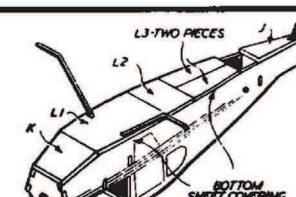

**7** Cement on bottom sheet covering K, L and J. Note notches in 'L' locate over wire legs. L3 does not meet 'J' leaving gap.

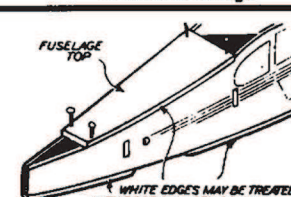

**8** Cement on fuselage top level with edge of former 'C', cementing down to brace. Clean up all edges neatly.

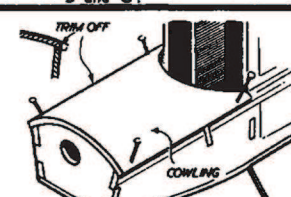

**9** Bevel sides slightly with sandpaper, then bend round cowling and cement down. Use pins to hold until set.

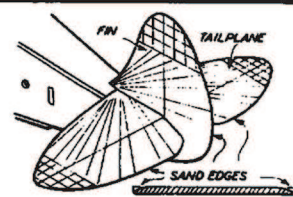

**10** Tailplane and fin edges are rounded with sandpaper. Cement tailplane to fuselage. Add fin. Check alignment.

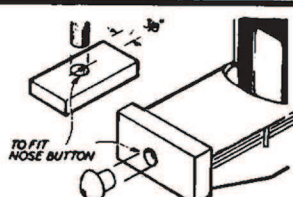

**11** Bore a hole in the noseblock in the position shown, using a piece of tube filed to a sharp edge or a drill.

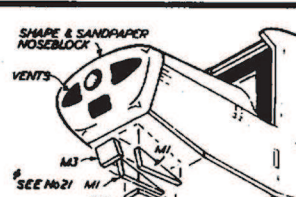

**12** Shape noseblock and finish smooth by sanding. Mark on vents with ball pen add 'M' parts to bottom of cowling.



**13** Run lines of cement across underside of each wing panel. This will curl up wings into aerofoil section when set.

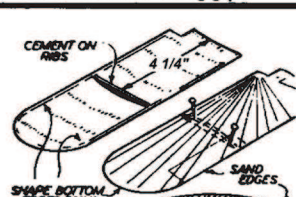

**14** Cement on ribs one to each wing at position shown. Edges are then shaped by sanding off bottom edges.

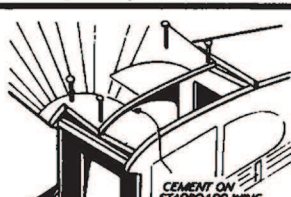

**15** Starboard wing can now be cemented to fuselage. Use pins to hold until set. Top shape of formers gives dihedral.

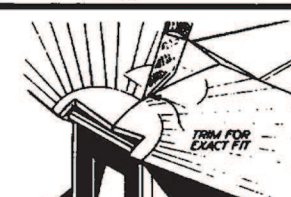

**16** Offer up the port wing and trim at centre for perfect fit against edge of starboard wing. Use sharp knife.

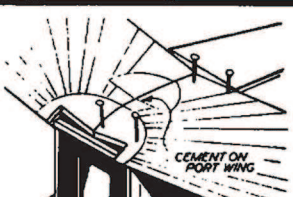

**17** Cement on port wing, again using pins to hold temporarily until set. Clean off any surplus cement before hard.



**18** Trim ends of wing struts to fit neatly. Sand unprinted sides of struts to section shown, then cement in place.

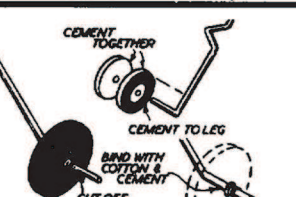

**19** Cement tailwheel discs together; push on and cement to leg. Main wheels must revolve freely on wire axles.

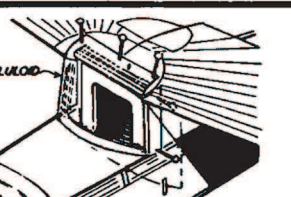

**20** Cut and trim celluloid to fit by trial and error. When satisfied, cement in place using pins to hold and locate.

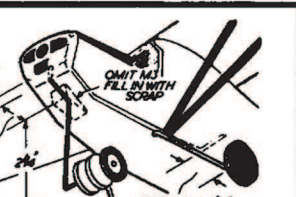

**21** For tri-pacer omit rear leg and bend a nosewheel leg to shape shown. Push end into noseblock. Bend main legs.

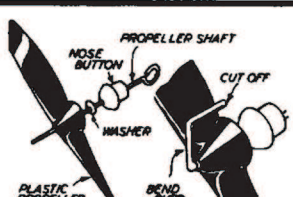

**22** Assemble button washer and propeller on prop. shaft. Bend back end of shaft to engage prop. and cut off surplus.

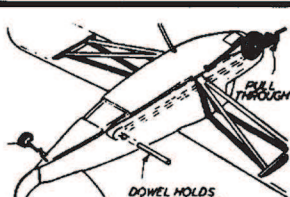

**23** Tie rubber in a 8" loop and draw through fuselage. Anchor rear of loop with dowel pushed through fuselage.



**24** Stick pins in wing tips at arrow marks and suspend on finger tips. If model does not balance level add weight.

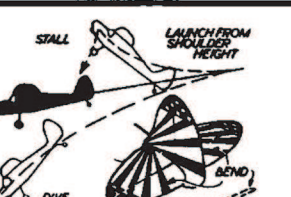

**25** Check glide of model. Elevators bent up to cure dive down to cure a stall. Ailerons adjust turn trim.

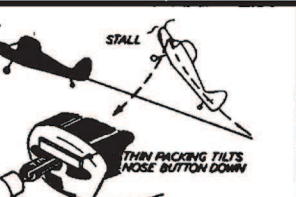

**26** Stalling under power is cured by cementing thin packing to noseblock to angle line of thrust downwards.

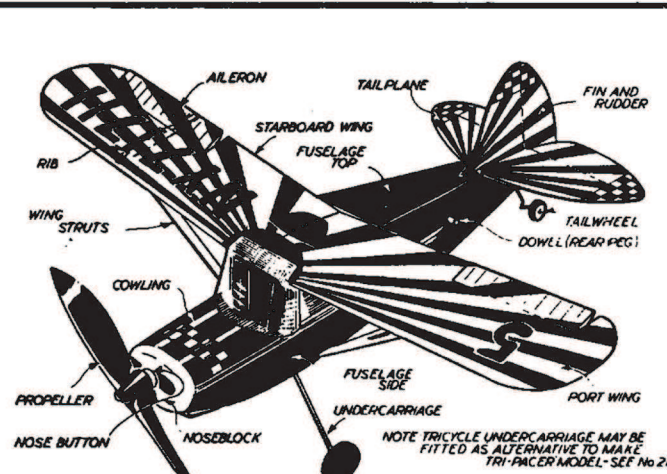

NOTE TRICYCLE UNDERCARRIAGE MAY BE FITTED AS ALTERNATIVE TO MAKE TRI-PACER MODEL—SEE No 21

# FROGFLITE



HALES

*Quick Build series*  
Rubber Powered Flying Scale Models

# PIPER PACER

